



POWER + LIGHT™

# PKM Series

**PKM30** 30 W  
**PKM50** 50 W

## 50 & 30 W Programmable Constant Current Class 2 LED Driver with 0-10 V Dimming

Input Voltage	Max. Output Power	Efficiency	Max. Case Temperature	THD	Power Factor	Dimming Method	Dimming Range	Startup Time
120 - 277 Vac	50 W	up to 90% typical	90°C (measured at the hot spot)	< 20%	> 0.9	Programmable 0 - 10 V	1 - 100%	300 ms typical

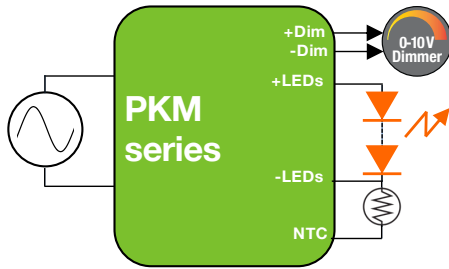

**Terminal Blocks (-TN),  
Metal Case w/ Bottom Studs**  
L 106.7 x W 60.3 x H 25.5 mm  
(L 4.20 x W 2.37 x H 1.00 in)

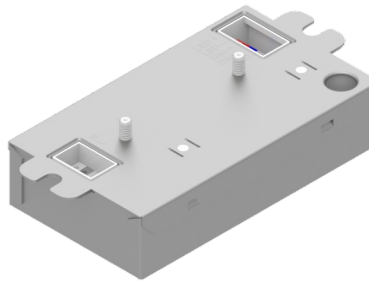

**Side Leads, No Studs (-NN),  
Metal Case**  
L 106.7 x W 60.3 x H 25.3 mm  
(L 4.20 x W 2.37 x H 0.99 in)



**Bottom Leads (-SN),  
Metal Case w/ Bottom Studs**  
L 106.7 x W 60.3 x H 25.3 mm  
(L 4.20 x W 2.37 x H 0.99 in)

### FEATURES

- UL Class P
- Class 2 output
- External NTC (negative temperature coefficient) functionality
- Lifetime: 5 years @ Tc ≤ 75°C
- 90°C maximum case hot spot temperature
- Surge protection:
  - IEC61000-4-5: 2 kV line to line/2 kV line to earth
  - 2.5 kV ring wave: ANSI/IEEE c62.41.1-2002 & c62.41.2-2002 category A
- Complies with DLC (DesignLight Consortium®) and CA Title 24 technical requirements

### PROGRAMMING

- Audio jack programming
- NTC derating profile
- Current: see page 2 for current range
- 0-10V dimming profiles: Linear, Non-linear, Logarithmic
- Data log read: SKU, S/N, lot code, hours of operation, FW rev., power cycles

### APPLICATIONS

- Commercial & residential lighting
- Architectural lighting
- Indoor Lighting

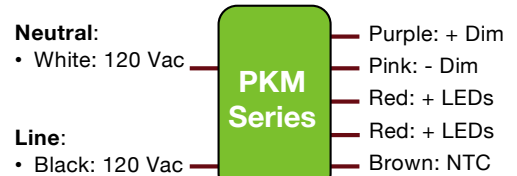

Wiring Diagrams





POWER + LIGHT™

# PKM Series

**PKM30** 30 W  
**PKM50** 50 W

## 50 & 30 W Programmable Constant Current Class 2 LED Driver with 0-10 V Dimming

### 1 - ORDERING INFORMATION

Part Number	Input Voltage (Vac)	Max Output Power (W)	Iout (mA)	Default Programmed Current (mA)	Vout Min. (Vdc)	Vout Nom. (Vdc)	Vout Max. (Vdc)*	Open Loop (No Load) Voltage (Vdc)	Notes
<b>PKM30W</b>									
PKM30W-1050-55-SN	120 - 277	30	275 to 1050	700	10	49.5	55	60	Bottom leads w/ studs
PKM30W-1050-55-TN	120 - 277	30	275 to 1050	700	10	49.5	55	60	Terminal blocks w/ studs
PKM30W-1050-55-NN	120 - 277	30	275 to 1050	700	10	49.5	55	60	Side leads no studs
<b>PKM50W</b>									
PKM50W-1400-55-SN	120 - 277	50	455 to 1400	1050	10	49.5	55	60	Bottom leads w/ studs
PKM50W-1400-55-TN	120 - 277	50	455 to 1400	1050	10	49.5	55	60	Terminal blocks w/ studs
PKM50W-1400-55-NN	120 - 277	50	455 to 1400	1050	10	49.5	55	60	Side leads no studs

\* The forward voltage (Vf) of the LED load should not exceed Vout Max. of the driver under worst case field operating conditions which are the Vf max. of the LED load under lowest temperature and highest forward current conditions. As a general design guideline, the nominal LED load Vf measured at the operating current and at room temperature should be ≤ Vout Nom. of the driver.

**Notes:**

- Please order the programming cable using the part number PROG-JACK-USB.

**Programming Cable**

Part number: PROG-JACK-USB



## 50 & 30 W Programmable Constant Current Class 2 LED Driver with 0-10 V Dimming

2 – OPERATING ENVELOPES (@25° C ambient temperature)

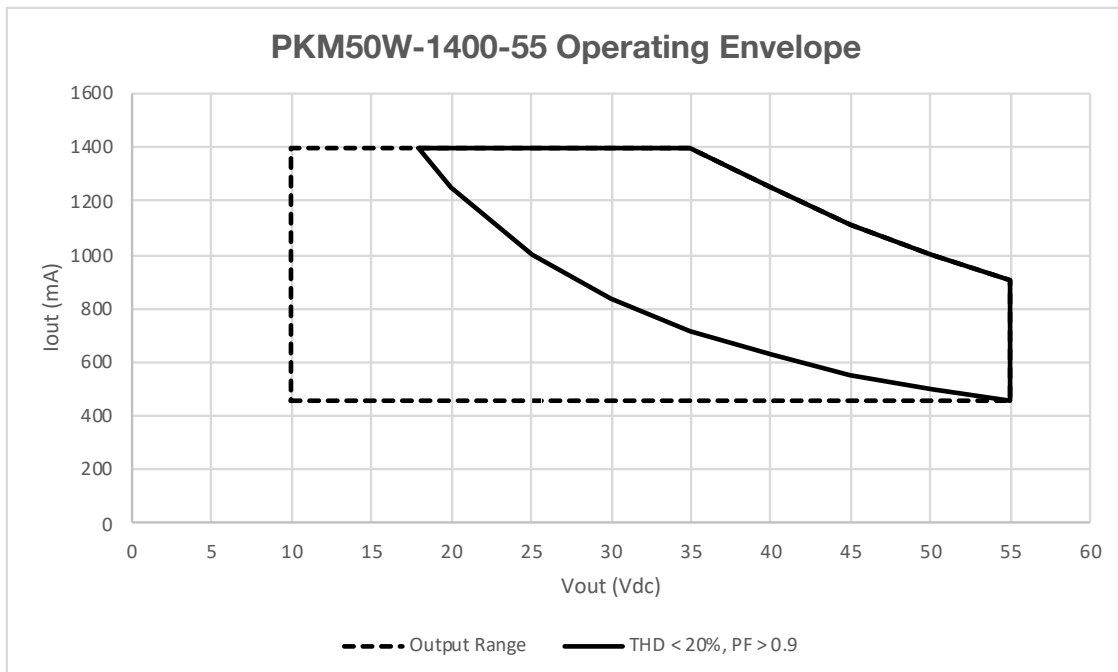
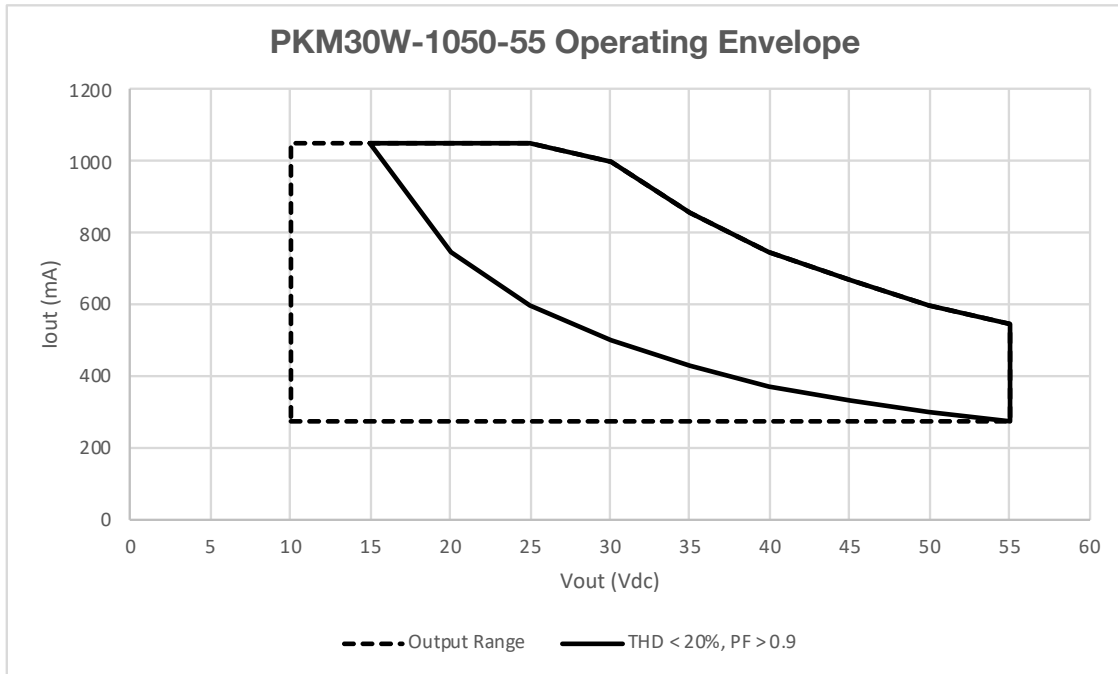



POWER + LIGHT™

# PKM Series

**PKM30** 30 W  
**PKM50** 50 W

## 50 & 30 W Programmable Constant Current Class 2 LED Driver with 0-10 V Dimming

### 3 - INPUT SPECIFICATION (@ 25°C ambient temperature)

	Units	Minimum	Typical	Maximum	Notes
<b>Input Voltage Range (Vin)</b>	Vac	90	120, 277	305	<ul style="list-style-type: none"> <li>The rated output current for each model is achieved at <math>V_{in} \geq 108</math> Vac, &amp; at <math>V_{in} \geq 249</math> Vac.</li> <li>At nominal load</li> </ul>
<b>Input Frequency Range</b>	Hz	47	50/60	63	
<b>Input Current (Iin)</b>	A			1.25 A @ 120 Vac 0.56 A @ 277 Vac	
<b>Power Factor (PF)</b>		0.9	> 0.9		<ul style="list-style-type: none"> <li>At nominal input voltage (120 &amp; 277 Vac) and no dimmer</li> <li>From 100% to 50% of output power</li> </ul>
<b>Inrush Current</b>	A	Meets NEMA-410 requirements			At any point on the sine wave and 25°C
<b>Leakage Current</b>	mA			0.4 mA @ 120 Vac 0.92 mA @ 277 Vac	Measured per IEC60950-1
<b>Input Harmonics</b>	Complies with IEC61000-3-2 for Class C equipment				
<b>Total Harmonics Distortion (THD)</b>				20%	<ul style="list-style-type: none"> <li>At nominal input voltage (120 &amp; 277 Vac)</li> <li>From 100% to 50% of output power</li> <li>Complies with DLC (Design Light Consortium) technical requirements.</li> </ul>
<b>Efficiency</b>	%	-	up to 90%	-	Measured with nominal input voltage, a full sinusoidal wave form and without dimmer attached.
<b>Standby Power</b>	W			1.4 1.7	<ul style="list-style-type: none"> <li>At 120 Vac</li> <li>At 277 Vac</li> </ul>
<b>Isolation</b>	The AC input to the main DC output is isolated.				

### 4 - MAIN OUTPUT SPECIFICATION (@ 25°C ambient temperature)

	Units	Minimum	Typical	Maximum	Notes
<b>Output Voltage (Vout)</b>	Vdc				See ordering information for details
<b>Output Current (Iout)</b>	mA				<ul style="list-style-type: none"> <li>See ordering information for details</li> <li>Output voltage and current combination cannot exceed max power output. See page 2 for operating window.</li> <li>The rated output current for each model is achieved at <math>V_{in} \geq 108</math> Vac &amp; <math>V_{in} \geq 249</math> Vac.</li> </ul>
<b>Output Current Regulation</b>	%	-5	±2.5	5	<ul style="list-style-type: none"> <li>At nominal input voltage (120 &amp; 277 Vac)</li> <li>Includes load and current set point variations.</li> </ul>
<b>Output Current Overshoot</b>	%	-	-	20	The driver does not operate outside of the regulation requirements for more than 500 ms during power on with nominal LED load and without dimmer.
<b>Ripple Current</b>	≤ 20% of rated output current for each model				<ul style="list-style-type: none"> <li>Measured at nominal LED voltage and nominal input voltage without dimming.</li> <li>Calculated in accordance with the IES Lighting Handbook, 9th edition.</li> </ul>
<b>Dimming Range</b>	%	1		100	<ul style="list-style-type: none"> <li>The dimming range is dependent on each specific dimmer. It may not be able to achieve 1% dimming with some dimmers.</li> <li>When testing, if light is measured, dimming range is based on light output. If no light is measured, dimming range is based on percentage of output current.</li> <li>Dimming performance is optimal when the driver is operated at its nominal output voltage matching the LED nominal Vf (forward voltage). Dimming performance may vary when the driver is operated near its minimum output voltage.</li> </ul>
<b>Start-up Time</b>	ms		300	500	<ul style="list-style-type: none"> <li>Without any dimmer attached, and at nominal input voltages and nominal load</li> <li>Measured from application of AC line voltage to 100% light output.</li> <li>Complies with ENERGY STAR® luminaire specification and CA Title 24.</li> </ul>
<b>Isolation</b>	The main DC output is certified and tested per UL8750 Class 2 or LED Class 2.				

## 50 & 30 W Programmable Constant Current Class 2 LED Driver with 0-10 V Dimming

### 5 - 0-10 V DIMMING CONTROL (@ 25°C ambient temperature)

In the PKM series, several 0-10V dimming profiles can be selected, such as a logarithmic profile, a non-linear profile with 1% minimum dimming, and a non-linear profile with 10% minimum dimming. Furthermore, every point in the non-linear dimming profile can be programmed using the programming software.

By default, the non-linear profile with 1% minimum dimming (shown in figure 1) is pre-loaded in the PKM series.

	Units	Minimum	Typical	Maximum	Notes
<b>+Dim Signal, -Dim Signal</b>		The PKM series operate only with 0-10 V dimmers that sink current. The method to dim the output current of the driver is done via the +Dim/-Dim Signal pins. The +Dim/-Dim signal pins can be used to adjust the output setting via a standard commercial wall dimmer, an external control voltage source (0 to 10 Vdc), or a variable resistor when using the recommended number of LEDs. The dimming input permits 1% to 100% dimming.			
<b>Dimming Profile (see figure 1)</b>		100% of output current between 10 V and 8.2 V, Linear between 8.2 V and 1.5 V, 1% of output current below 1.5 V.			
<b>Dimming Range</b>	%	0.1		100	When testing, if light is measured, dimming range is based on light output. If no light is measured, dimming range is based on percentage of output current.
<b>High Level Voltage - A</b>	V		8.2	8.5	
<b>Low Level Voltage - B</b>	V	0.5	1.5		
<b>Current Supplied by the +Dim Signal Pin</b>	mA			1	
<b>Output Current Tolerance While Being Dimmed</b>	%			±8	The tolerance of the output current while being dimmed is ≤ +/-8% until down to 1.5V.
<b>Minimum Dimming Tolerance</b>	%	0.8	1	2	
<b>Isolation</b>	The 0-10 V circuit is isolated from the AC input and meets UL8750 supplement SF requirements.				

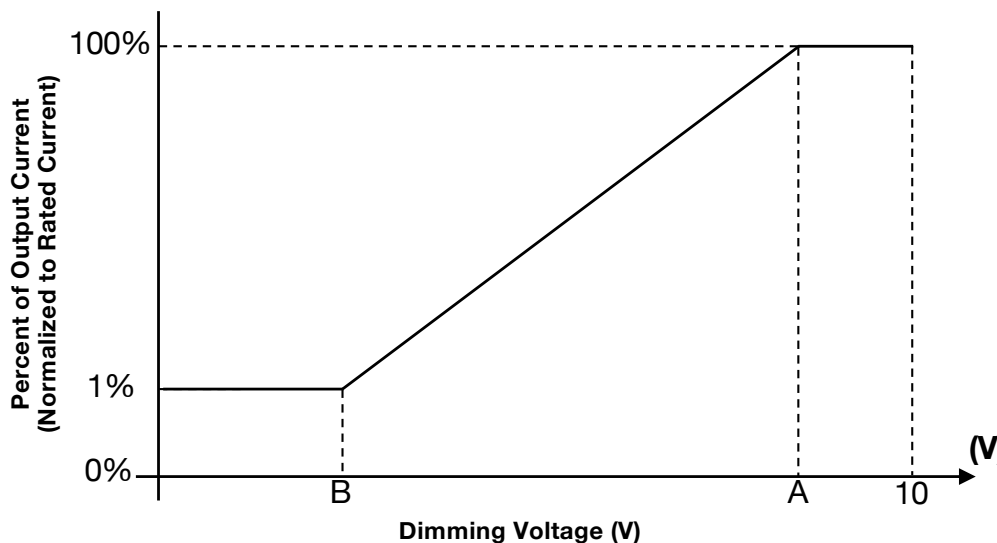

Figure 1



POWER + LIGHT™

# PKM Series

**PKM30** 30 W  
**PKM50** 50 W

## 50 & 30 W Programmable Constant Current Class 2 LED Driver with 0-10 V Dimming

### 6 - ENVIRONMENTAL CONDITIONS

	Units	Minimum	Typical	Maximum	Notes
<b>Operating Ambient Temperature (Ta)</b>	°C	-20		50	50°C is the non-derated temperature (Refer to section 9 'Output power de-rating at elevated temperatures'.)
<b>Maximum Case Temperature (Tc)</b>	°C			+90	Case temperature measured at the hot spot •tc (see label on page 18)
<b>Storage Temperature</b>	°C	-40		+85	
<b>Humidity</b>	%	5	-	95	Non-condensing
<b>Cooling</b>	Convection cooled				
<b>Acoustic Noise</b>	dBA			24	Measured at a distance of 1 foot, without dimmer
<b>Mechanical Shock Protection</b>	per EN60068-2-27				
<b>Vibration Protection</b>	per EN60068-2-6 & EN60068-2-64				
<b>MTBF</b>	> 200,000 hours when operated at nominal input and output conditions, and at Tc ≤ 75°C				
<b>Lifetime</b>	50,000 hours at Tc ≤ 75°C maximum case hot spot temperature (see hot spot •tc on label on page 18)				
<b>Warranty</b>	5 years. Users must utilize proper thermal management techniques to ensure proper thermal conductivity between the driver and heat sink. The use of double-sided tape to mount the driver voids the warranty.				

### 7 - EMC COMPLIANCE AND SAFETY APPROVALS

#### EMC Compliance

<b>Conducted and Radiated EMI</b>	•Compliant with FCC CFR Title 47 Part 15 Class A at 120 & 277 Vac		
<b>Harmonic Current Emissions</b>	IEC61000-3-2	For Class C equipment	
<b>Voltage Fluctuations &amp; Flicker</b>	IEC61000-3-3		
<b>Immunity Compliance</b>	<b>ESD (Electrostatic Discharge)</b>	IEC61000-4-2	6 kV contact discharge, 8 kV air discharge, level 3
	<b>RF Electromagnetic Field Susceptibility</b>	IEC61000-4-3	3 V/m, 80 - 1000 MHz, 80% modulated at a distance of 3 meters
	<b>Electrical Fast Transient</b>	IEC61000-4-4	± 2 kV on AC power port for 1 minute, ±1 kV on signal/control lines
	<b>Surge</b>	IEC61000-4-5	± 2 kV line to line (differential mode) / ± 2 kV line to common mode ground
			ANSI/IEEE c62.41.1-2002 & c62.41.2-2002 category A, 2.5 kV ring wave
	<b>Conducted RF Disturbances</b>	IEC61000-4-6	3V, 0.15-80 MHz, 80% modulated
<b>Voltage Dips</b>	IEC61000-4-11	>95% dip, 0.5 period; 30% dip, 25 periods; 95% reduction, 250 periods	

#### Safety Agency Approvals

<b>UL</b>	UL8750 listed Class 2, supplement SF
<b>cUL</b>	CAN/CSA C22.2 No. 250.13-14 LED equipment for lighting applications
<b>NOM</b>	

#### Safety

	Units	Minimum	Typical	Maximum	Notes
<b>Hi Pot (High Potential) or Dielectric voltage-withstand</b>	Vdc	2200			<ul style="list-style-type: none"> <li>•Tested at the RMS voltage equivalent of 1556 Vac.</li> <li>•Insulation between the input (AC line and Neutral) and the output</li> </ul>



POWER + LIGHT™

# PKM Series

**PKM30** 30 W  
**PKM50** 50 W

## 50 & 30 W Programmable Constant Current Class 2 LED Driver with 0-10 V Dimming

### 8 - PROTECTION FEATURES

#### **Input Over Current Protection**

The PKM series incorporates a primary AC line fuse for input over current protection to prevent damage to the LED driver and meet product safety requirements as outlined in Section 6.

#### **Short Circuit and Over Current Protection**

The PKM series is protected against short-circuit such that a short from any output to return shall not result in a fire hazard or shock hazard. The driver shall hiccup as a result of a short circuit or over current fault. Removal of the fault will return the driver to within normal operation. The driver shall recover, with no damage, from a short across the output for an indefinite period of time.

#### **Internal Over temperature Protection**

The PKM series is equipped with internal temperature sensor on the primary power train. Failure to stay within the convection power rating will result in the power supply reducing the available current (fold back) below the programmed amount. The main output current will be restored to the programmed value when the temperature of the built-in temperature sensor cools adequately.

#### **Output Open Load Protection**

When the LED load is removed, the output voltage of the PKM series is typically limited to 1.3 times the maximum output voltage of each model.

### 9 - OUTPUT POWER DE-RATING AT ELEVATED TEMPERATURES

The PKM series can be operated with cooling air temperatures above 50°C by linearly de-rating the total maximum output power (or current) by 2.5%/°C until internal over temperature protection activates.

## 50 & 30 W Programmable Constant Current Class 2 LED Driver with 0-10 V Dimming

### 10 - 0-10 V DIMMING

The PKM series operate only with 0-10 V dimmers that sink current. They are not designed to operate with 0-10 V control systems that source current, as used in theatrical/entertainment systems. Developed in the 1980's, the 0-10 V sinking current control method is adopted by the International Electrotechnical Commission (IEC) as part of its IEC Standard 60929 Annex E.

The method to dim the output current of the driver is done via the +Dim/-Dim Signal pins. The +Dim/-Dim Signal pins respond to a 0 to 10 V signal, delivering 1% to 100% of the output current based on rated current for each model. A pull-up resistor is included internal to the driver. If the +Dim input is > 10 V or open circuited, the output current is programmed to 100% of the rated current.

The maximum source current (flowing from the driver to the 0-10 V dimmer) supplied by the +Dim Signal pin is  $\leq 1$  mA. The tolerance of the output current while being dimmed shall be  $\pm 8\%$  typical until down to 1.5 V.

In the PKM series, several 0-10 V dimming profiles can be selected, such as a logarithmic profile, a non-linear profile with 1% minimum dimming, and a non-linear profile with 10% minimum dimming.

By default, the non-linear profile with 1% minimum dimming (shown in figure 2) is pre-loaded in the PKM50/30 series. In this non-linear 0-10 V dimming profile, 10 V to 8.2 V = 100% of the output current,  $< 1.5$  V = 1%,

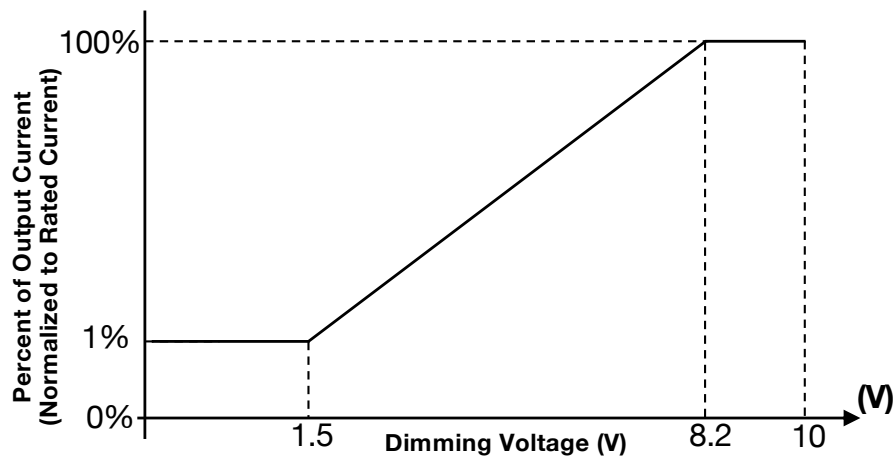

Figure 2

### 11 - COMPATIBLE 0-10 V DIMMERS

- Lutron, Nova series (part number NFTV)
- Lutron, Diva series (part number DVTV)
- Leviton, IllumaTech series (part number IP710-DL)



## 50 & 30 W Programmable Constant Current Class 2 LED Driver with 0-10 V Dimming

### 12 - PROGRAMMING

The PKM series can be programmed by inserting the audio jack of the cable shown in figure 3 into the driver and by plugging the USB other end of the cable into a computer. **The driver does not need to be powered on during the programming process.**

When ordering the PKM series, please make sure you order a programming cable. The part number for the programming cable is “PROG-JACK-USB”.

Programming is done by using the ERP GUI (Graphical User Interface), which enables the user to adjust output current and dimming profile.

Please note that, for each model, the **default output current setting is listed on page 2 of this datasheet.**

Furthermore, when connecting the driver to a computer using the programming cable, you can access the driver’s internal data log and read the following information: SKU, serial number, manufacturing lot code, hours of operation, firmware revision, and power cycles.

While programming drivers in a lot, the ERP GUI can interface with a label printer, which enables the user to add configuration labels to driver labels in order to highlight programmed output current. Listed below is the equipment needed to print labels.

Equipment	Part Number	Where to buy
Printer	TSC TC210	<a href="http://barcodefactory.com/tsc/printers/tc210/99-059a001-54f">barcodefactory.com/tsc/printers/tc210/99-059a001-54f</a>
Ribbon	TSC Prem. Resin, 60mm x 110mm	<a href="http://barcodefactory.com/tsc/35-r060110-23cf">barcodefactory.com/tsc/35-r060110-23cf</a>
Labels	BAR-.81x.28-1-TT	<a href="http://barcodefactory.com/barcodefactory/labels/bar-.81x.28-1-tt">barcodefactory.com/barcodefactory/labels/bar-.81x.28-1-tt</a>

For more information, please refer to the GUI user’s manual at: [erp-power.com/our-products/programming-software/](http://erp-power.com/our-products/programming-software/)



Figure 3

## 50 & 30 W Programmable Constant Current Class 2 LED Driver with 0-10 V Dimming

### 13 – EXTERNAL NTC FUNCTIONALITY

The PKM series can be used with an external NTC thermistor to reduce output current at elevated ambient temperatures. The following values can be set with the ERP GUI, which enables the user to adjust output current and dimming profile:

External NTC Functionality: Allows user to disable functionality, enable functionality, or enable functionality with a flashing effect when in the derated region

Recovery Threshold: Value at which driver returns to 100% output

Top Trigger Threshold: Value at which driver begins derating output current

Bottom Trigger Threshold: Value at which driver reaches minimum percentage of output current

Minimum NTC Throttle: Percentage of output current at and below Bottom Trigger Threshold

By default, the PKM series has external NTC functionality disabled, and utilizes the internal overtemperature protection outlined in section 9. Figure 4 below shows the default values of the PKM series' external NTC functionality. Resistor values can be customized from 200 – 20,000 Ω.

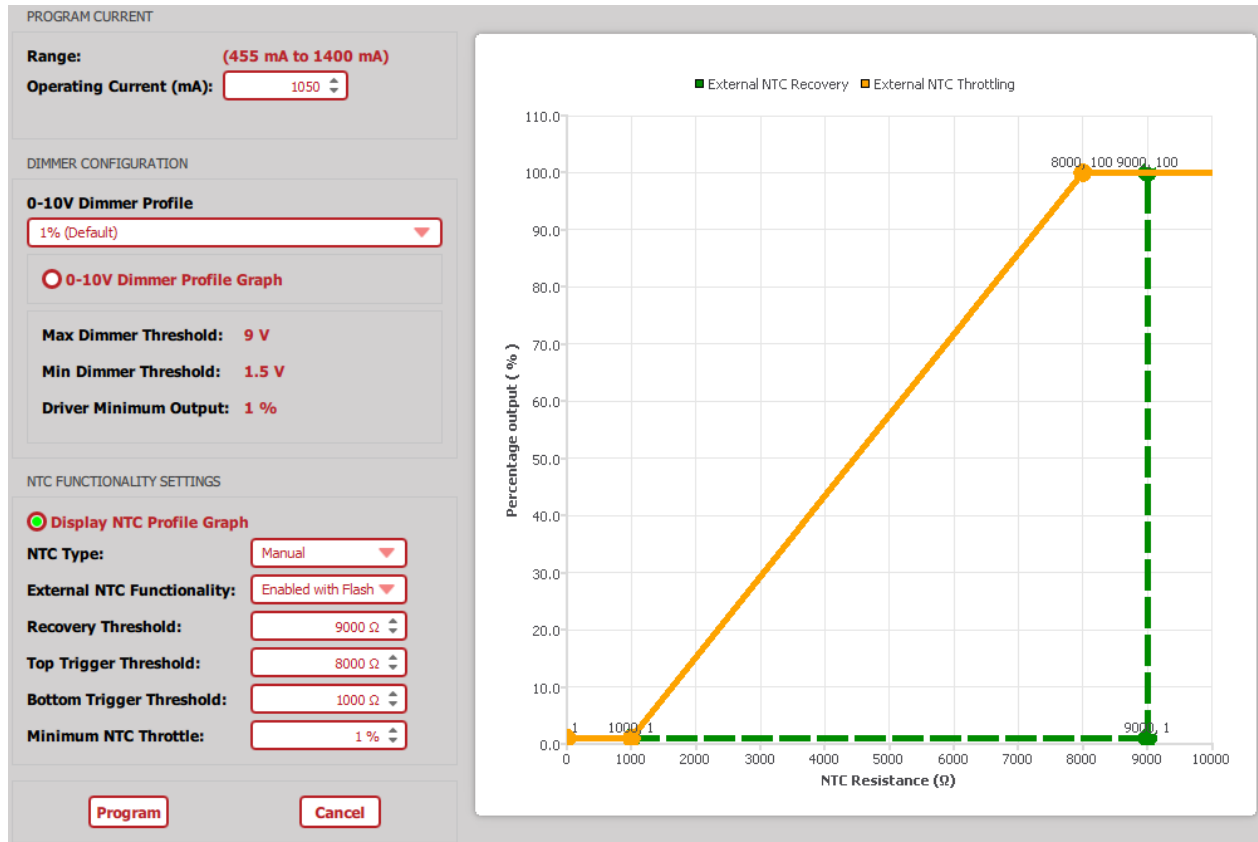

Figure 4

## 50 & 30 W Programmable Constant Current Class 2 LED Driver with 0-10 V Dimming

### 14 - PREDICTED LIFETIME VERSUS CASE AND AMBIENT TEMPERATURE

Lifetime is defined by the measurement of the temperatures of all the electrolytic capacitors whose failure would affect light output under the nominal LED load and worst case AC line voltage. The graphs in figures 5 and 6 are determined by the electrolytic capacitor with the shortest lifetime, among all electrolytic capacitors. It represents a worst case scenario in which the LED driver is powered 24 hours/day, 7 days/week. The lifetime of an electrolytic capacitor is measured when any of the following changes in performance are observed:

- 1) Capacitance changes more than 20% of initial value
- 2) Dissipation Factor ( $\tan \delta$ ): 150% or less of initial specified value
- 3) Equivalent Series Resistance (ESR): 150% or less of initial specified value
- 4) Leakage current: less of initial specified value

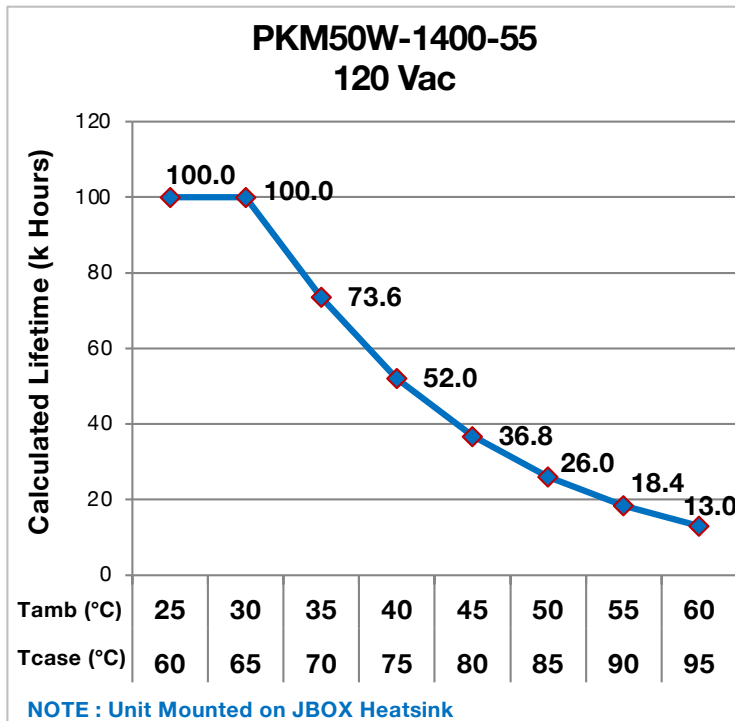

Figure 5

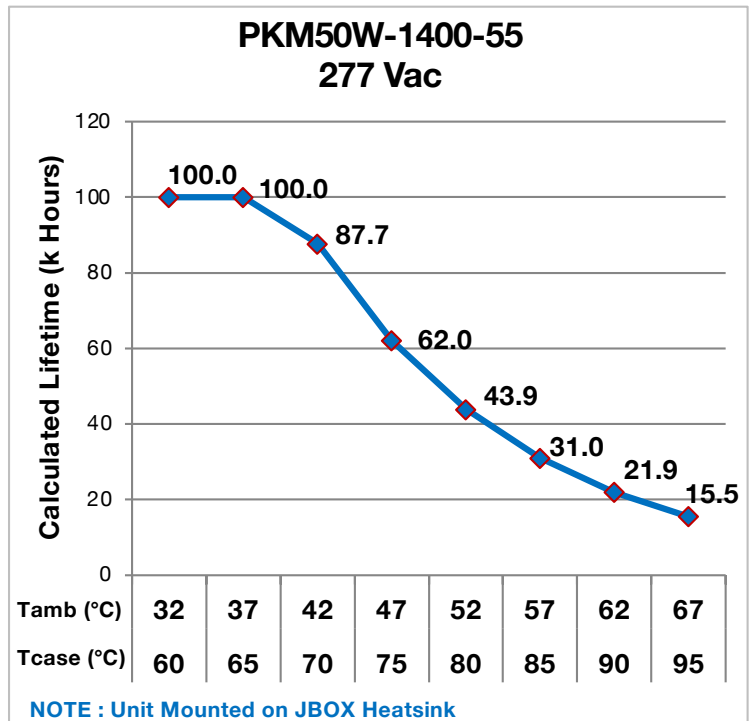

Figure 6

Notes:

- The ambient temperature  $T_{ambient}$  and the differential between  $T_{ambient}$  and  $T_{case}$  mentioned in the above graphs are relevant only as long as both the driver and the light fixture are exposed to the same ambient room temperature. If the LED driver is housed in an enclosure or covered by insulation material, then the ambient room temperature is no longer valid. In this situation, please refer only to the case temperature  $T_{case}$ .
- It should be noted the graph "Lifetime vs. Ambient Temperature" may have an error induced in the final application if the mounting has restricted convection flow around the case. For applications where this is evident, the actual case temperature measured at the Tc point in the application should be used for reliability calculations.
- Users must utilize proper thermal management techniques to ensure proper thermal conductivity between the driver and heat sink. The use of double-sided tape to mount the driver voids the warranty.

## 50 & 30 W Programmable Constant Current Class 2 LED Driver with 0-10 V Dimming

15 – EFFICIENCY VERSUS OUTPUT VOLTAGE (100% OF IO<sub>UT</sub>)

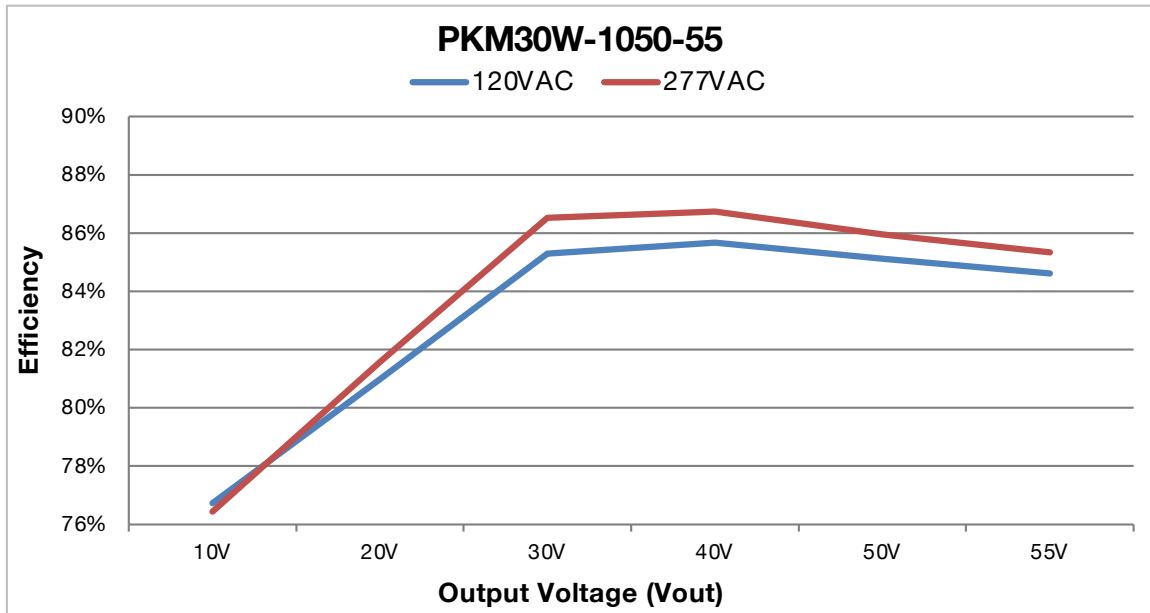

Figure 7

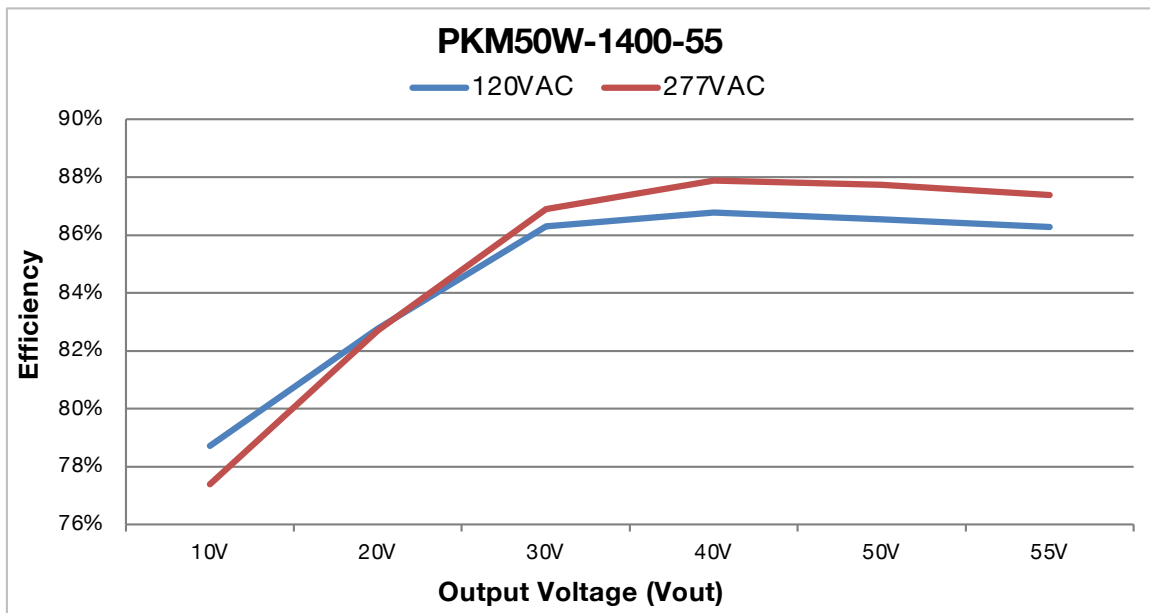

Figure 8

## 50 & 30 W Programmable Constant Current Class 2 LED Driver with 0-10 V Dimming

16 – POWER FACTOR VERSUS OUTPUT VOLTAGE (100% OF IO<sub>UT</sub>)

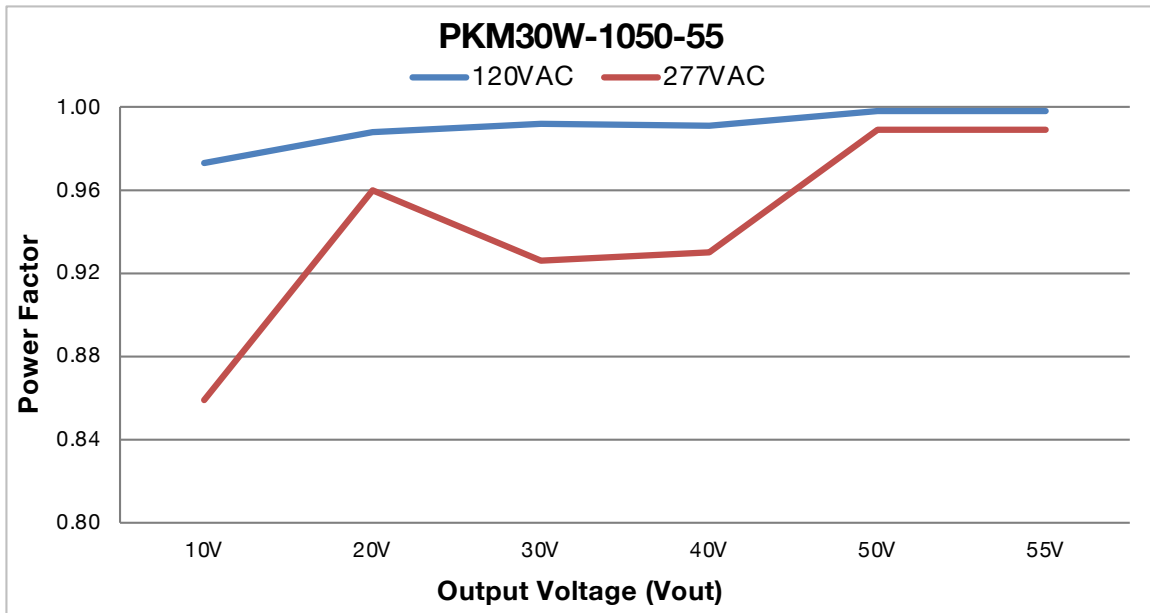

Figure 9

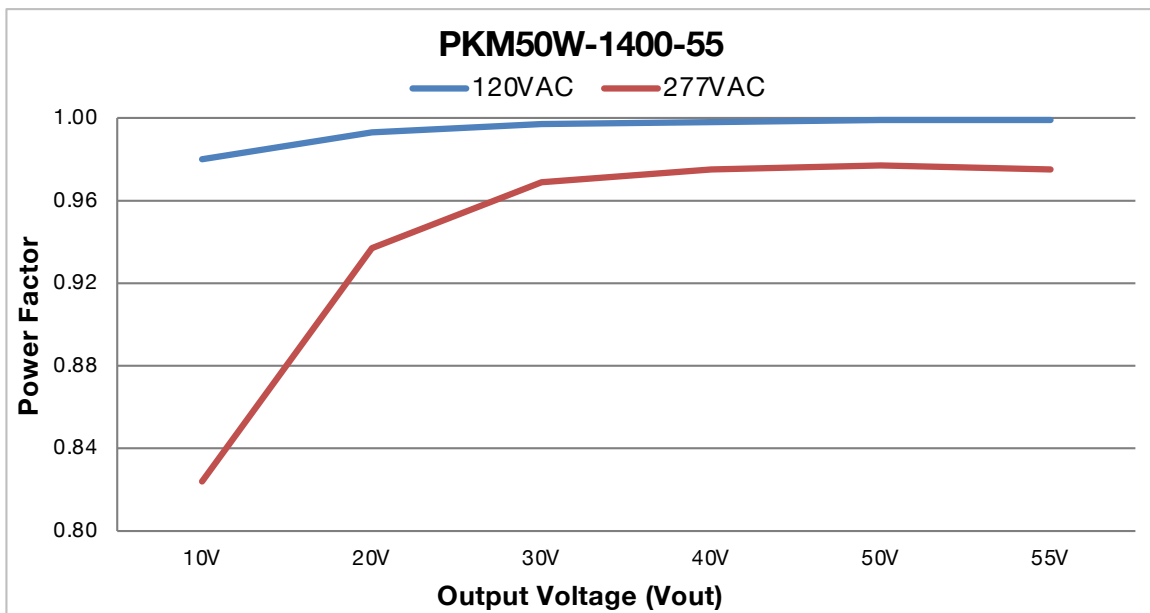

Figure 10

## 50 & 30 W Programmable Constant Current Class 2 LED Driver with 0-10 V Dimming

17 – THD VERSUS OUTPUT VOLTAGE (100% OF IOU)

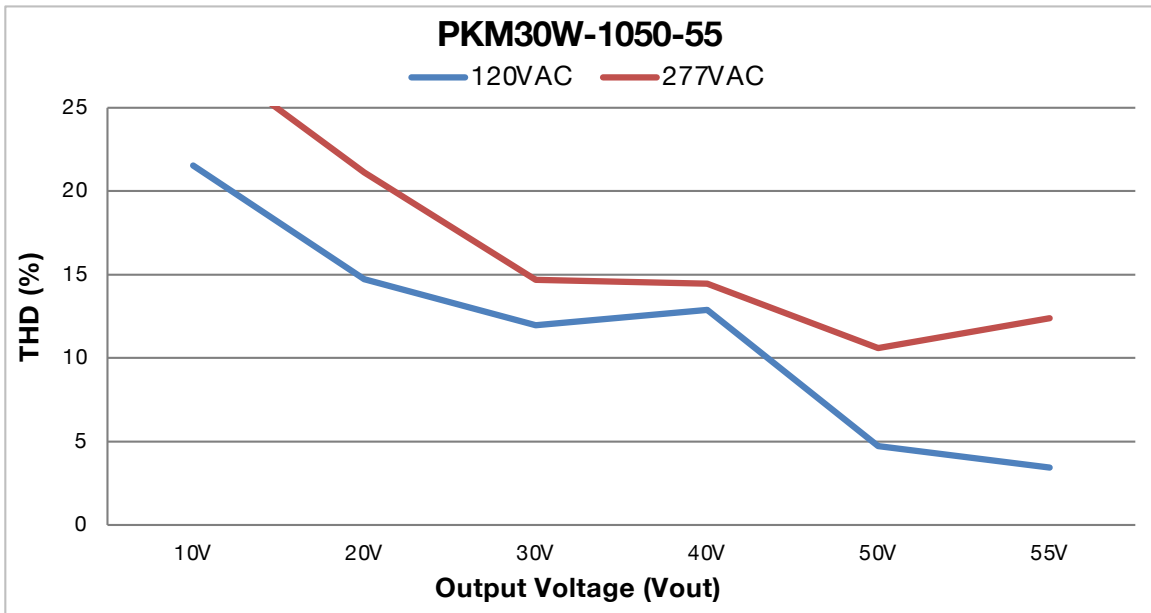

Figure 11

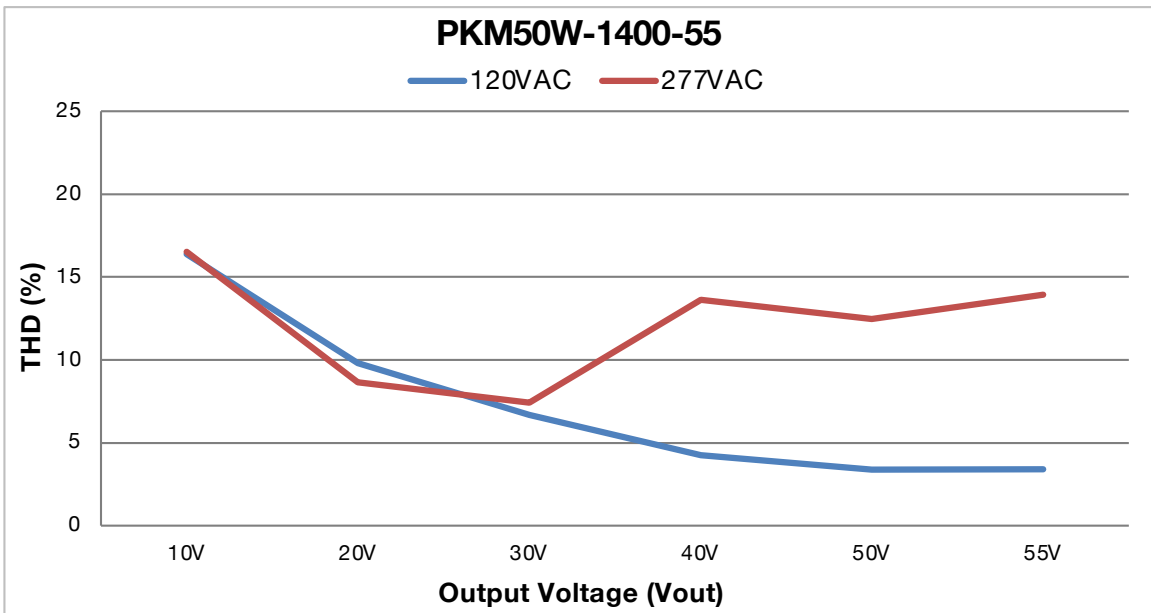

Figure 12

## 50 & 30 W Programmable Constant Current Class 2 LED Driver with 0-10 V Dimming

### 14 - MECHANICAL DETAILS

- **Packaging:** Aluminum case
- **I/O Connections:**
  - **Models with “-TN” suffix:** Terminal Blocks
  - **Models with “-SN” suffix:** 18 AWG on all leads, 162 mm (6.38 in) long, 105°C rated, stranded, stripped by approximately 9.5mm, and tinned. All the wires, on both input and output, have a 300 V insulation rating.
  - **Models with “-NN” suffix:** 18 AWG on all leads, 300 mm (11.81 in) long, 105°C rated, stranded, stripped by approximately 9.5mm, and tinned. All the wires, on both input and output, have a 300 V insulation rating.
- **Ingress Protection:** IP20 rated
- **Mounting Instructions:** The PKM driver case must be secured on a flat surface through the two mounting tabs, shown here below in the case outline drawings. The use of double-sided tape voids the warranty.

### 15 - OUTLINE DRAWINGS (MODELS WITH “-TN” SUFFIX)

**Dimensions:** L 106.7 x W 60.3 x H 25.5 mm (L 4.20 x W 2.37 x H 1.00 in.)

**Volume:** 164 cm<sup>3</sup> (9.95 in<sup>3</sup>)

**Weight:** 280 g (9.9 oz)

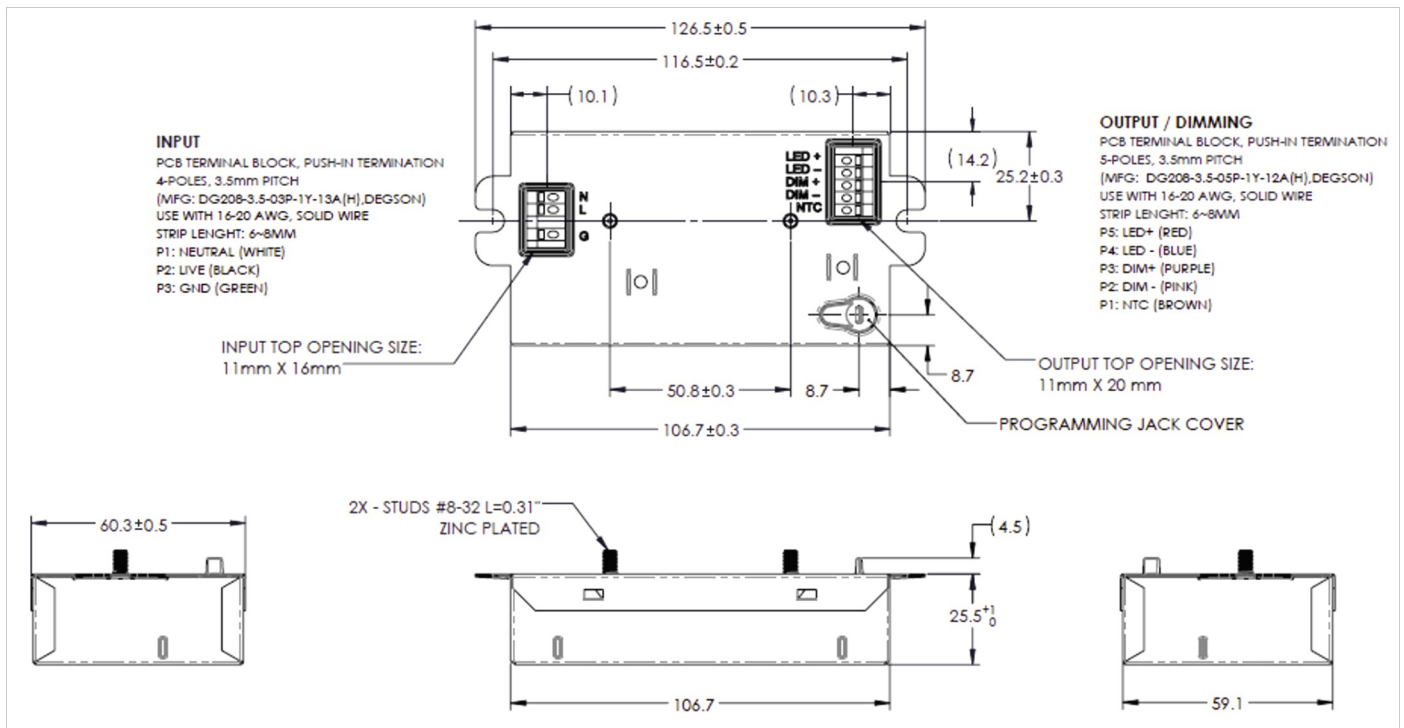

**Figure 13**

## 50 & 30 W Programmable Constant Current Class 2 LED Driver with 0-10 V Dimming

**16 - OUTLINE DRAWINGS (MODELS WITH "-SN" SUFFIX)**

**Dimensions:** L 106.7 x W 60.3 x H 25.3 mm (L 4.20 x W 2.37 x H 0.99 in.)

**Volume:** 163 cm<sup>3</sup> (9.85 in<sup>3</sup>)

**Weight:** 290 g (10.2 oz)

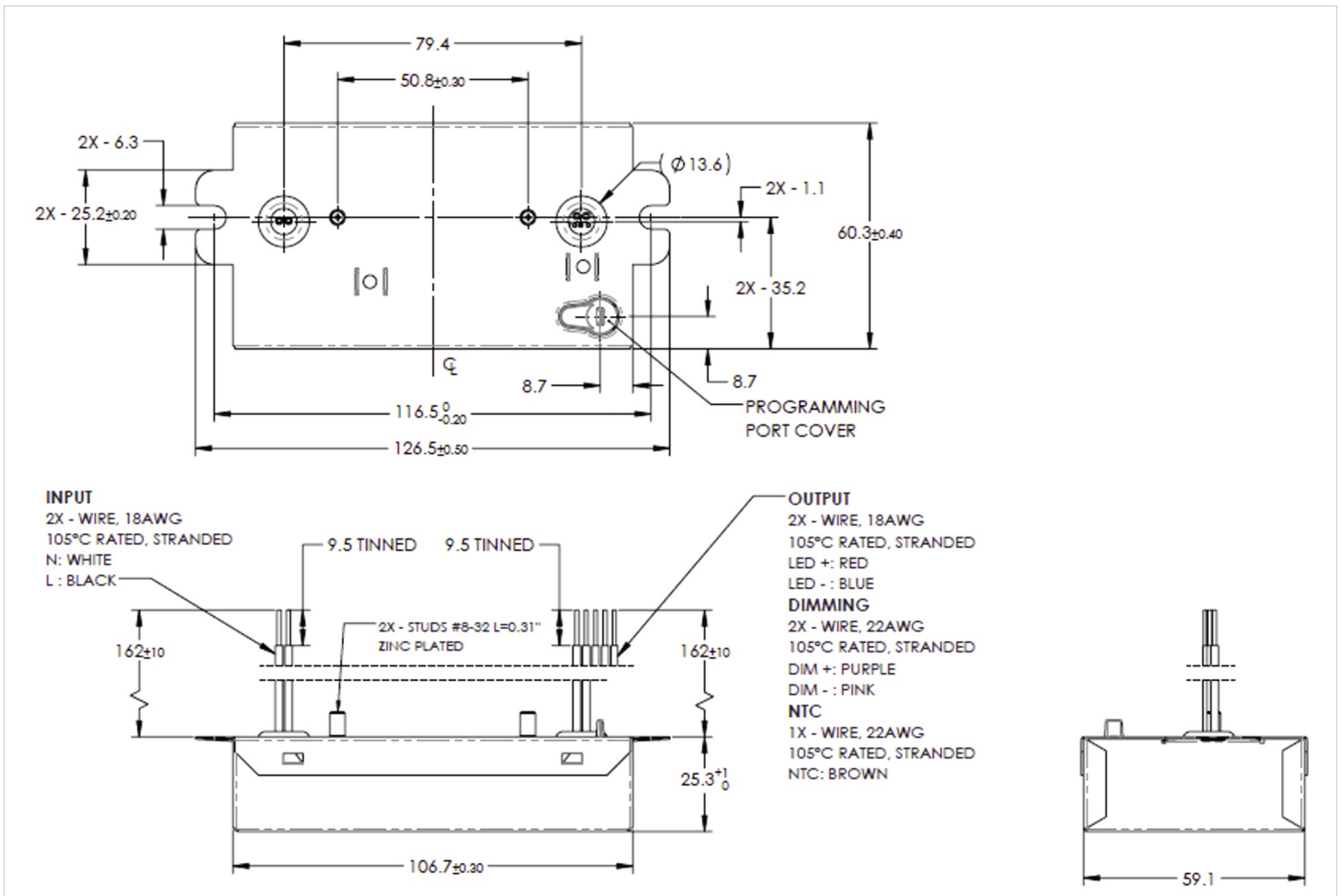

All dimensions are in mm

**Figure 14**



## 50 & 30 W Programmable Constant Current Class 2 LED Driver with 0-10 V Dimming

### 17 - OUTLINE DRAWINGS (MODELS WITH "-NN" SUFFIX)

**Dimensions:** L 106.7 x W 60.3 x H 25.3 mm (L 4.20 x W 2.37 x H 0.99 in.)

**Volume:** 163 cm<sup>3</sup> (9.85 in<sup>3</sup>)

**Weight:** 300 g (10.6 oz)

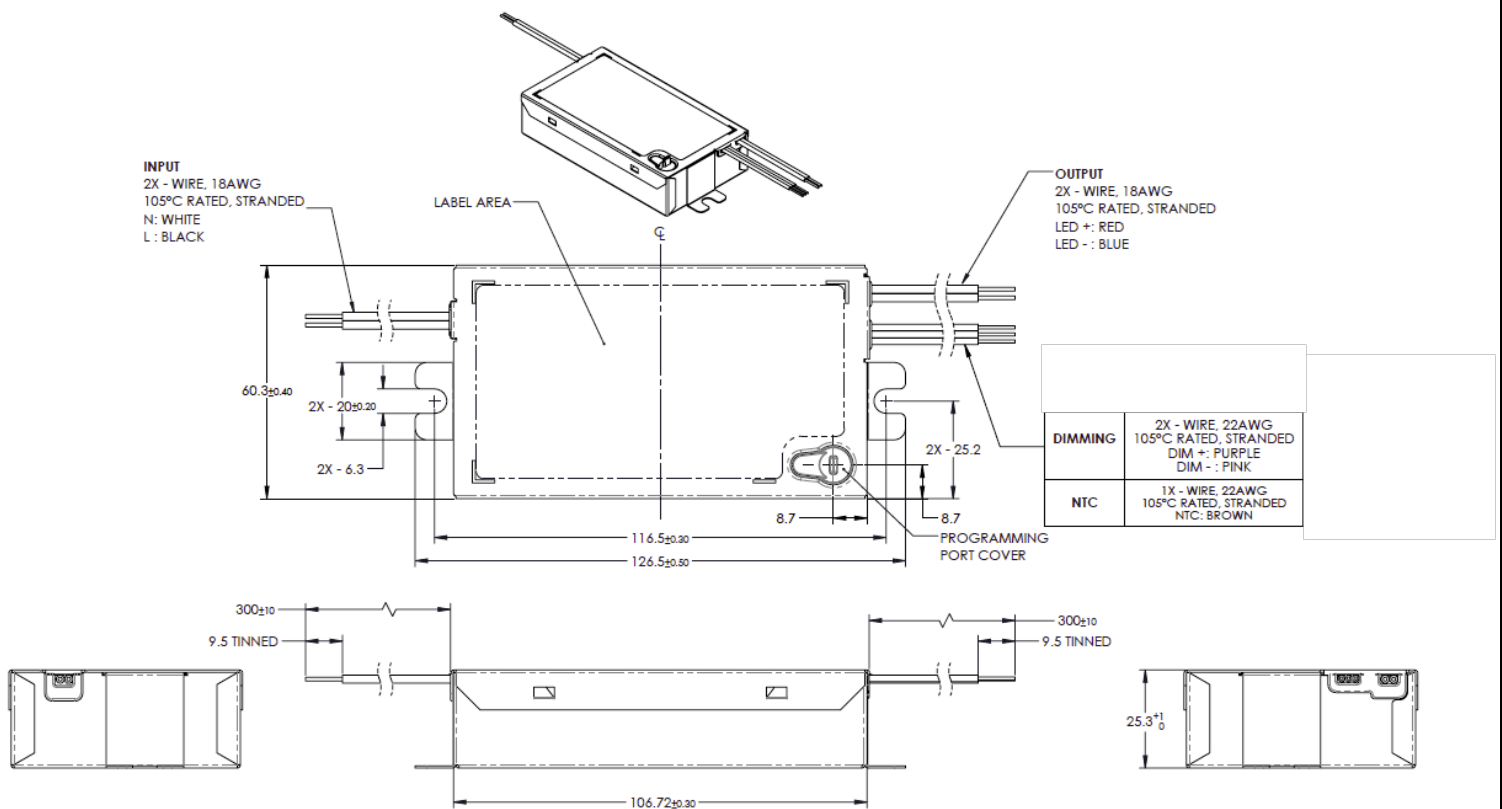

All dimensions are in mm

**Figure 15**



POWER + LIGHT™

# PKM Series

**PKM30** 30 W  
**PKM50** 50 W

## 50 & 30 W Programmable Constant Current Class 2 LED Driver with 0-10 V Dimming

### 18 - LABELING

The PKM50W-1400-55-SN is used in figure 16 as an example to illustrate a typical label.

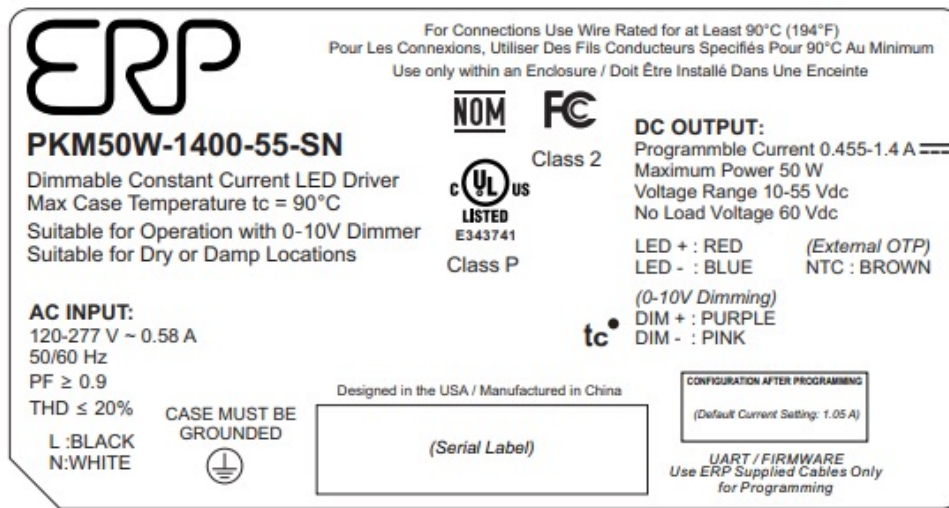

Figure 16

#### USA Headquarters

Tel: +1-805-517-1300  
Fax: +1-805-517-1411  
2625 Townsgate Road, Suite 106  
Westlake Village, CA 91361, USA

#### CHINA Operations

Tel: +86-756-6266298  
Fax: +86-756-6266299  
No. 8 Pingdong Road 2  
Zhuhai, Guangdong, China 519060

ERP Power, LLC (ERP) reserves the right to make changes without further notice to any products herein. ERP makes no warranty, representation or guarantee regarding the suitability of its products for any particular purpose, nor does ERP assume any liability arising out of the application or use of any product or circuit, and specifically disclaims any and all liability, including without limitation special, consequential or incidental damages. "Typical" parameters which may be provided in ERP data sheets and/or specifications can and do vary in different applications and actual performance may vary over time. All operating parameters, including "Typicals" must be validated for each customer application by customer's technical experts. ERP does not convey any license under its patent rights nor the rights of others. ERP products are not designed, intended, or authorized for use as components in systems intended for surgical implant into the body, or other applications intended to support or sustain life, or for any other application in which the failure of the ERP product could create a situation where personal injury or death may occur. Should Buyer purchase or use ERP products for any such unintended or unauthorized application, Buyer shall indemnify and hold ERP and its officers, employees, subsidiaries, affiliates, and distributors harmless against all claims, costs, damages, and expenses, and reasonable attorney fees arising out of, directly or indirectly, any claim of personal injury or death associated with such unintended or unauthorized use, even if such claim alleges that ERP was negligent regarding the design or manufacture of the part. ERP is an Equal Opportunity/Affirmative Action Employer. This literature is subject to all applicable copyright laws and is not for resale in any manner.



POWER + LIGHT™

# PKM Series

**PKM30** 30 W  
**PKM50** 50 W

## 50 & 30 W Programmable Constant Current Class 2 LED Driver with 0-10 V Dimming

### Revision History

Date	Comments
07APR2021	• Initial datasheet
30SEP2021	• Clarified input voltage
07DEC2021	• Added "-NN", "-SN", "-TN" part numbers
19JAN2022	• Added NOM certification
29MAR2023	• Pg1: added RoHS logo • Pg2: removed "-ND", "-SD", "-NS" part numbers • Pg5,8: corrected dimming voltage values for default dimming profile