

## Low Profile (0.72" H x 0.72" W), Programmable, Constant Current Class 2 LED Driver with 0-10 V Dimming

Nominal Input Voltage	Max. Output Power	Efficiency	Max. Case Temperature	THD	Power Factor	Dimming Method	Dimming Range	Startup Time
120 & 277 Vac	50 W	up to 90% typical	90°C (measured at the hot spot)	< 20%	> 0.9	0 - 10V	1 - 100%	300 ms typical

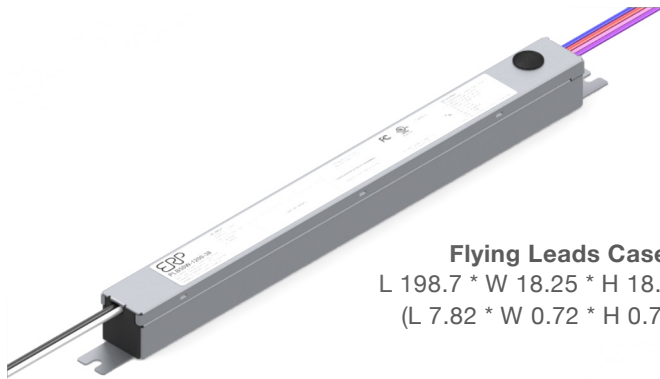

**Flying Leads Case**  
 L 198.7 \* W 18.25 \* H 18.25 mm  
 (L 7.82 \* W 0.72 \* H 0.72 in.)

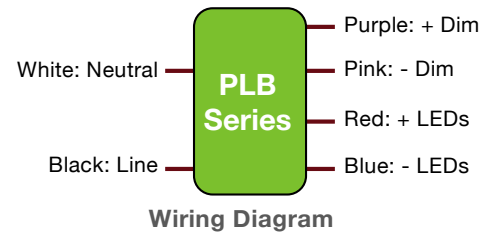

### FEATURES

- Non-linear 0–10 V dimming profile pre-loaded by default (10 V to 8.2 V = 100%, 8.2 to 1.0 V = linear, < 1.0 V = 1%)
- The 0–10 V circuit is isolated from both the AC input and the DC output.
- Dimming is achieved by using linear constant current reduction
- UL Class P
- Class 2 power supply
- Lifetime: 50,000 hours @ Tc = 75 °C
- 90 °C maximum case hot spot temperature
- IP20-rated case with silicone-based potting
- Indoor surge protection:
  - IEC61000-4-5: 2 kV line to line/2 kV line to earth
  - 2.5 kV ring wave: ANSI/IEEE c62.41.1-2002 & c62.41.2-2002 category A
- Complies with ENERGY STAR®, DLC (DesignLight Consortium®) and CA Title 24 technical requirements
- Meets IEEE 1789-2015 “no impact” recommended practices for flicker

### PROGRAMMING

- Serial port programming
  - Current: 100% to 50% in each voltage range
  - Data log read: SKU, S/N, lot code, hours of operation, FW rev.
- Fully programmable and selectable 0-10V dimming profiles: Non-linear with dim-to-off, Logarithmic, Non-Linear without dim-to-off.

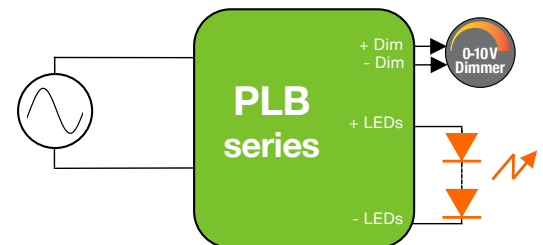



POWER + LIGHT™

# PLB50/30/15 Series

**PLB50** 50 W  
**PLB30** 30 W  
**PLB15** 15 W

## Low Profile (0.72" H x 0.72" W), Programmable, Constant Current Class 2 LED Driver with 0-10 V Dimming

### 1 - ORDERING INFORMATION

ERP Part Number	Nominal Input Voltage (Vac)	Max Output Power (W)	Iout (mA)	Vout Min. (Vdc)	Vout Nom. (Vdc)	Vout Max. (Vdc)*	Open Loop (No Load) Voltage (Vdc)	Comments
<b>15 W</b>								
PLB15W-0300-38	120 & 277	11.4	100 to 300	26	32	38	50	Side leads
<b>30 W</b>								
PLB30W-0600-38	120 & 277	22.8	300 to 600	26	32	38	50	Side leads
<b>50 W</b>								
PLB50W-1200-38	120 & 277	45.6	600 to 1200	26	32	38	50	Side leads

\* The forward voltage (Vf) of the LED load should not exceed Vout Max. of the driver under worst case field operating conditions which are the Vf max. of the LED load under lowest temperature and highest forward current conditions. As a general design guideline, the nominal LED load Vf measured at the operating current and at room temperature should be ≤ Vout Nom. of the driver.

**Notes:**

- Please order the programming cable using the part number PROG-JACK-USB.

#### Programming Cable

Part number: PROG-JACK-USB



## Low Profile (0.72" H x 0.72" W), Programmable, Constant Current Class 2 LED Driver with 0-10 V Dimming

### 2 - INPUT SPECIFICATION (@25°C ambient temperature)

	Units	Minimum	Typical	Maximum	Notes
<b>Input Voltage Range (Vin)</b>	Vac	90	120 & 277	305	<ul style="list-style-type: none"> <li>The rated output current for each model is achieved at <math>V_{in} \geq 108</math> Vac &amp; at <math>V_{in} \geq 249</math> Vac</li> <li>At nominal load</li> </ul>
<b>Input Frequency Range</b>	Hz	47	60	63	
<b>Input Current (Iin)</b>	A			0.5 A @ 120 Vac 0.23 A @ 277 Vac	
<b>Power Factor (PF)</b>		0.9	> 0.9		<ul style="list-style-type: none"> <li>At nominal input voltage and with nominal LED voltage</li> <li>From 100% to 60% of output current</li> </ul>
<b>Inrush Current</b>	A	Meets NEMA-410 requirements			At any point on the sine wave and 25°C
<b>Leakage Current</b>	mA			0.3 mA @ 120 Vac 0.7 mA @ 277 Vac	Measured per IEC60950-1
<b>Input Harmonics</b>	Complies with IEC61000-3-2 for Class C equipment				
<b>Total Harmonics Distortion (THD)</b>				20%	<ul style="list-style-type: none"> <li>At nominal input voltage and nominal LED voltage and no dimmer</li> <li>From 100% to 60% of output current</li> <li>Complies with DLC (Design Light Consortium) technical requirements</li> </ul>
<b>Efficiency</b>	%	82%	up to 90%	-	<ul style="list-style-type: none"> <li>Measured with nominal input voltage, a full sinusoidal wave form and without dimmer attached.</li> <li>The PLB15W-0300-38 has a nominal power range of 9.6 W (when programmed at 300 mA) down to 3.2 W (when programmed at 100 mA). The efficiency of the PLB15W-0300-38 will be <math>\geq 78\%</math> for nominal output power <math>\leq 10</math>W and <math>\geq 75\%</math> for nominal output power <math>\leq 5</math>W.</li> </ul>
<b>Isolation</b>	The AC input to the main DC output is isolated.				

### 3 - MAIN OUTPUT SPECIFICATION (@25°C ambient temperature)

	Units	Minimum	Typical	Maximum	Notes
<b>Output Voltage (Vout)</b>	Vdc				See ordering information for details
<b>Output Current (Iout)</b>	mA				<ul style="list-style-type: none"> <li>See ordering information for details</li> <li>The rated output current for each model is achieved at <math>V_{in} \geq 108</math> Vac &amp; at <math>V_{in} \geq 198</math> Vac.</li> </ul>
<b>Output Current Regulation</b>	%	-5	$\pm 2.5$	5	<ul style="list-style-type: none"> <li>At nominal AC line voltage</li> <li>Includes load and current set point variations</li> </ul>
<b>Output Current Overshoot</b>	%	-	-	10	The driver does not operate outside of the regulation requirements for more than 500 ms during power on with nominal LED load and without dimmer.
<b>Ripple Current</b>		$\leq 10\%$ of rated output current @ 100% load & frequency > 94 kHz $\leq 25\%$ of rated output current @ 20% load & frequency > 94 kHz			<ul style="list-style-type: none"> <li>Measured at nominal LED voltage and nominal input voltage</li> <li>Calculated in accordance with the IES Lighting Handbook, 9th edition</li> <li>Meets IEEE 1789-2015 "no impact" recommended practices for flicker</li> </ul>
<b>Dimming Range</b>	%	1		100	<ul style="list-style-type: none"> <li>The dimming range is dependent on each specific dimmer. It may not be able to achieve 1% dimming with some dimmers.</li> <li>When testing, if light is measured, dimming range is based on light output. If no light is measured, dimming range is based on percentage of output current.</li> <li>Dimming performance is optimal when the driver is operated at its nominal output voltage matching the LED nominal Vf (forward voltage). Dimming performance may vary when the driver is operated near its minimum output voltage.</li> </ul>
<b>Start-up Time</b>	ms		300	500	<ul style="list-style-type: none"> <li>Without any dimmer attached, and at nominal input voltages and nominal load</li> <li>Measured from application of AC line voltage to 100% light output</li> <li>Complies with ENERGY STAR® luminaire specification and CA Title 24</li> </ul>
<b>Isolation</b>	The main DC output is certified and tested per UL8750 LVLE.				



POWER + LIGHT™

# PLB50/30/15 Series

**PLB50** 50 W  
**PLB30** 30 W  
**PLB15** 15 W

## Low Profile (0.72" H x 0.72" W), Programmable, Constant Current Class 2 LED Driver with 0-10 V Dimming

### 4 - 0-10 V DIMMING CONTROL (@25°C ambient temperature)

The 0-10V profile with 1% minimum dimming (show in figure 1) and no dim-to-off is pre-loaded as the default profile in the driver.

Other pre-defined 0-10V dimming profiles can be selected, such as a logarithmic profile, a non-linear profile with 1% minimum dimming and dim-to-off, and a non-linear profile with 10% minimum dimming and no dim-to-off. Furthermore, every point in the non-linear dimming profile can be programmed using the programming software.

Dimming is achieved by using linear constant current reduction.

0-10V dimming is also protected from mis-wiring of AC to 0-10V dimming for all nominal AC input voltage.

	Units	Minimum	Typical	Maximum	Notes
<b>+Dim Signal, -Dim Signal</b>		The PLB driver series operate only with 0-10V dimmers that sink current. The method to dim the output current of the driver is done via the +Dim/-Dim Signal pins. The +Dim/-Dim signal pins can be used to adjust the output setting via a standard commercial wall dimmer, an external control voltage source (0 to 10 Vdc), or a variable resistor when using the recommended number of LEDs. The dimming input permits 1% to 100% dimming.			
<b>Dimming Profile (see figure 1)</b>		100% of output current between 10 V and 8.0 V, Linear between 8.0 V and 1.0 V, 1% of output current below 1.0 V.			
<b>Dimming Range</b>	%	1		100	When testing, if light is measured, dimming range is based on light output. If no light is measured, dimming range is based on percentage of output current.
<b>High Level Voltage - A</b>	V		8.2		
<b>Low Level Voltage - B</b>	V		1.0		
<b>Current Supplied by the +Dim Signal Pin</b>	mA			1	
<b>Output Current Tolerance While Being Dimmed</b>	%		±8		In the linear region of the dimming curve (Between points A and B in Figure 1)
<b>Output Current Tolerance at Minimum Dimming</b>	%		±8		The tolerance of the output current at minimum dimming is +/-8% of 1% of the maximum output current of each driver.
<b>Minimum Dimming Tolerance</b>	%	0.8	1	2	
<b>Isolation</b>	The 0-10 V circuit is isolated from the AC input and meets UL8750 supplement SF requirements.				

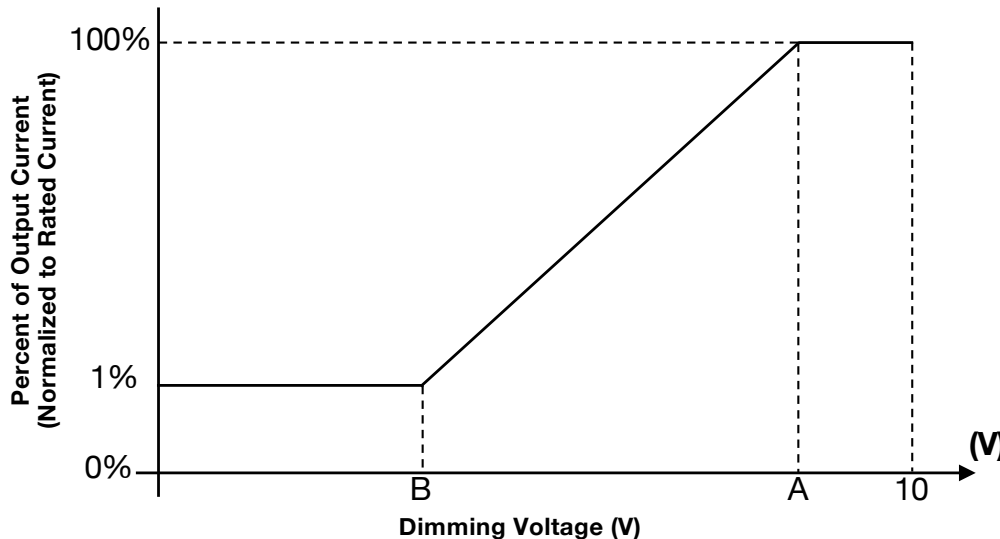

Figure 1

## Low Profile (0.72" H x 0.72" W), Programmable, Constant Current Class 2 LED Driver with 0-10 V Dimming

### 5 - ENVIRONMENTAL CONDITIONS

	Units	Minimum	Typical	Maximum	Notes
<b>Operating Ambient Temperature (Ta)</b>	°C	-20		50	
<b>Maximum Case Temperature (Tc)</b>	°C			+90	Case temperature measured at the hot spot •tc (see label on page 14).
<b>Storage Temperature</b>	°C	-40		+85	
<b>Humidity</b>	%	5	-	95	Non-condensing
<b>Cooling</b>	Convection cooled				
<b>Acoustic Noise</b>	dBA			22	Measured at a distance of 1 foot, without dimmer
<b>Mechanical Shock Protection</b>	per EN60068-2-27				
<b>Vibration Protection</b>	per EN60068-2-6 & EN60068-2-64				
<b>MTBF</b>	> 200,000 hours when operated at nominal input and output conditions, and at Tc ≤ 75°C				
<b>Lifetime</b>	50,000 hours at Tc ≤ 75°C maximum case hot spot temperature (see hot spot •tc on label on page 14).				
<b>Warranty</b>	5 years. Users must utilize proper thermal management techniques to ensure proper thermal conductivity between the driver and heat sink. The use of double-sided tape to mount the driver voids the warranty.				

### 6 - EMC COMPLIANCE AND SAFETY APPROVALS

EMC Compliance						
<b>Conducted and Radiated EMI</b>	Compliant with FCC CFR Title 47 Part 15 Class B at 120 Vac & Class A at 277 Vac					
<b>Harmonic Current Emissions</b>	IEC61000-3-2	For Class C equipment				
<b>Voltage Fluctuations &amp; Flicker</b>	IEC61000-3-3					
<b>Immunity Compliance</b>	<b>ESD (Electrostatic Discharge)</b>	IEC61000-4-2	6 kV contact discharge, 8 kV air discharge, level 3			
	<b>RF Electromagnetic Field Susceptibility</b>	IEC61000-4-3	3 V/m, 80 - 1000 MHz, 80% modulated at a distance of 3 meters			
	<b>Electrical Fast Transient</b>	IEC61000-4-4	± 2 kV on AC power port for 1 minute, ±1 kV on signal/control lines			
	<b>Surge</b>	IEC61000-4-5	± 2 kV line to line (differential mode) / ± 2 kV line to common mode ground			
		ANSI/IEEE c62.41.1-2002 & c62.41.2-2002 category A, 2.5 kV ring wave				
	<b>Conducted RF Disturbances</b>	IEC61000-4-6	3V, 0.15-80 MHz, 80% modulated			
<b>Voltage Dips</b>	IEC61000-4-11	>95% dip, 0.5 period; 30% dip, 25 periods; 95% reduction, 250 periods				
Safety Agency Approvals						
<b>UL</b>	UL8750 listed LVLE, Class P					
<b>cUL</b>	CAN/CSA C22.2 No. 250.13-14 LED equipment for lighting applications					
Safety						
	Units	Minimum	Typical	Maximum	Notes	
<b>Hi Pot (High Potential) or Dielectric voltage-withstand</b>	Vdc	2500			<ul style="list-style-type: none"> <li>• Insulation between the input (AC line and Neutral) and the output</li> <li>• Tested at the RMS voltage equivalent of 1767 Vac</li> </ul>	



POWER + LIGHT™

# PLB50/30/15 Series

<b>PLB50</b>	<b>50 W</b>
<b>PLB30</b>	<b>30 W</b>
<b>PLB15</b>	<b>15 W</b>

## Low Profile (0.72" H x 0.72" W), Programmable, Constant Current Class 2 LED Driver with 0-10 V Dimming

### 7 - PROTECTION FEATURES

#### Input Over Current Protection

The PLB customer LED driver series incorporates a primary AC line fuse for input over current protection to prevent damage to the LED driver and meet product safety requirements as outlined in Section 6.

#### Short Circuit and Over Current Protection

The PLB customer LED driver series is protected against short-circuit such that a short from any output to return shall not result in a fire hazard or shock hazard. The driver shall hiccup as a result of a short circuit or over current fault. Removal of the fault will return the driver to within normal operation. The driver shall recover, with no damage, from a short across the output for an indefinite period of time.

#### Internal Over temperature Protection

The PLB customer LED driver series is equipped with internal temperature sensor on the primary power train. Failure to stay within the convection power rating will result in the power supply reducing the available current (fold back) below the programmed amount. The main output current will be restored to the programmed value when the temperature of the built-in temperature sensor cools adequately.

#### Output Open Load Protection

When the LED load is removed, the output voltage of the PLB customer LED driver series is typically limited to 1.3 times the maximum output voltage of each model.

#### Protection on 0-10V Dimming Wires

0-10V dimming is also protected from mis-wiring of AC to 0-10V dimming for all nominal AC input voltage.

## Low Profile (0.72" H x 0.72" W), Programmable, Constant Current Class 2 LED Driver with 0-10 V Dimming

### 8 - 0-10 V DIMMING

The PLB50/30/15 series operate only with 0-10V dimmers that sink current. They are not designed to operate with 0-10V control systems that source current, as used in theatrical/entertainment systems. Developed in the 1980's, the 0-10V sinking current control method is adopted by the International Electrotechnical Commission (IEC) as part of its IEC Standard 60929 Annex E.

The method to dim the output current of the driver is done via the +Dim/-Dim Signal pins. The +Dim/-Dim Signal pins respond to a 0 to 10 V signal, delivering 1% to 100% of the output current based on rated current for each model. A pull-up resistor is included internal to the driver. When the +Dim wire (purple) is short circuited to the -Dim wire (pink) or to the -LED wire (blue), the output current turns off.

If the +Dim input is > 10 V or open circuited, the output current is programmed to 100% of the rated current. When not used, the -Dim wire (pink) and to the +Dim wire (purple) can be individually capped or cut off. In this configuration, no dimming is possible and the driver delivers 100% of its rated output current.

The maximum source current (flowing from the driver to the 0-10V dimmer) supplied by the +Dim Signal pin is  $\leq 1$  mA. The tolerance of the output current while being dimmed shall be  $\pm 8\%$  typical until down to 1.5 V.

In the PLB50/30/15 series, several 0-10V dimming profiles can be selected, such as a logarithmic profile, a non-linear profile with 1% minimum dimming and dim-to-off, and a non-linear profile with 10% minimum dimming and no dim-to-off. Furthermore, every point in the non-linear dimming profile can be programmed using the programming software.

By default, the non-linear profile with 1% minimum dimming (show in figure 2) is pre-loaded in the PLB50/30/15 series. In this non-linear 0-10V dimming profile, 10V to 8.2V=100% of the output current, <1.0V =1%.

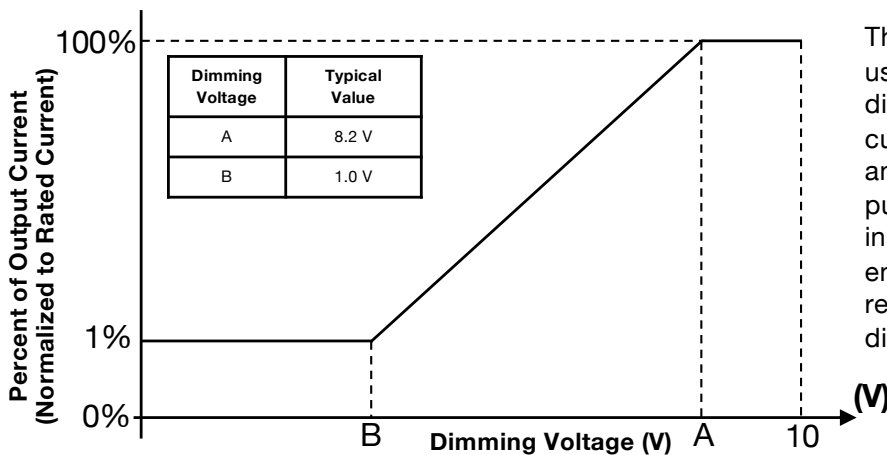

Figure 2

The non-linear curve is recommended when using standard in-wall 0-10 V logarithmic dimmers to avoid having insufficient source current available to pull the dimmer up to 10V and to account for the inability of the dimmer to pull below approximately 0.9V. In these type of installations, the modified transfer function will ensure 100% light output and dimming to 1%, regardless of the number of drivers on the 0-10V dimming line.

### 9 - COMPATIBLE 0-10 V DIMMERS

- Lutron, Nova series (part number NFTV)
- Lutron, Diva series (part number DVTV)
- Leviton, IllumaTech series (part number IP710-DL)

## Low Profile (0.72" H x 0.72" W), Programmable, Constant Current Class 2 LED Driver with 0-10 V Dimming

### 9 - PROGRAMMING

The PLB50/30/15 series can be programmed by inserting the audio jack of the cable shown in figure 3 into the driver and by plugging the USB other end of the cable into a computer. **The driver does not need to be powered on during the programming process.**

When ordering the PLB50/30/15 series, please make sure you order a programming cable. The part number for the programming cable is "PROG-JACK-USB".

Programming is done by using the ERP GUI (Graphical User Interface), which enables the user to adjust output current from 100% to 50%.

Please note that, for each model, the **default output current setting is the minimum current.** For example, the default output current setting for the PLB50W-1200-38 is 600 mA.

Furthermore, when connecting the driver to a computer using the programming cable, you can access the driver's internal data log and read the following information: SKU, serial number, manufacturing lot code, hours of operation, firmware revision, and fault events: power failure, transients (short or surge), thermal events (i.e. number of times the case temperature has exceed the maximum case temperature of 90°C).

While programming drivers in a lot, the ERP GUI can interface with a label printer, which enables the user to add configuration labels to driver labels in order to highlight programmed output current. Listed below is the equipment needed to print labels.

Equipment	Part Number	Where to buy
Printer	TSC TC210	<a href="http://barcodefactory.com/tsc/printers/tc210/99-059a001-54f">barcodefactory.com/tsc/printers/tc210/99-059a001-54f</a>
Ribbon	TSC Prem. Resin, 60mm x 110mm	<a href="http://barcodefactory.com/tsc/35-r060110-23cf">barcodefactory.com/tsc/35-r060110-23cf</a>
Labels	BAR-.81x.28-1-TT	<a href="http://barcodefactory.com/barcodefactory/labels/bar-.81x.28-1-tt">barcodefactory.com/barcodefactory/labels/bar-.81x.28-1-tt</a>

For more information, please refer to the GUI user's manual at: [erp-power.com/our-products/programming-software/](http://erp-power.com/our-products/programming-software/)



Figure 3



## Low Profile (0.72" H x 0.72" W), Programmable, Constant Current Class 2 LED Driver with 0-10 V Dimming

### 10 - PREDICTED LIFETIME VERSUS CASE AND AMBIENT TEMPERATURE

Lifetime is defined by the measurement of the temperatures of all the electrolytic capacitors whose failure would affect light output under the nominal LED load and worst case AC line voltage. The graph in figure 4 are determined by the electrolytic capacitor with the shortest lifetime, among all electrolytic capacitors. It represents a worst case scenario in which the LED driver is powered 24 hours/day, 7 days/week. The lifetime of an electrolytic capacitor is measured when any of the following changes in performance are observed:

- |  |  |
|--|--|
| 1) Capacitance changes more than 20% of initial value                          | 2) Dissipation Factor ( $\tan \delta$ ): 150% or less of initial specified value |
| 3) Equivalent Series Resistance (ESR): 150% or less of initial specified value | 4) Leakage current: less of initial specified value                              |

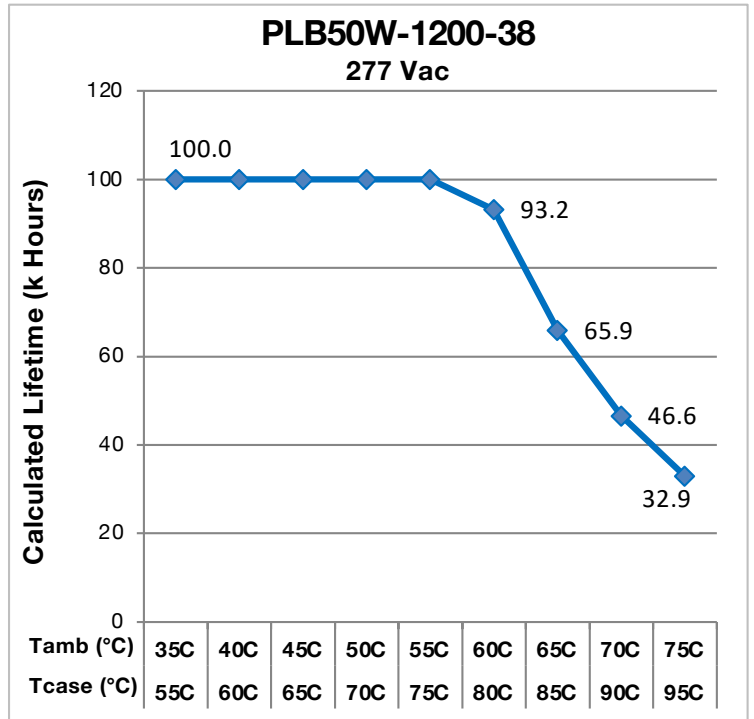
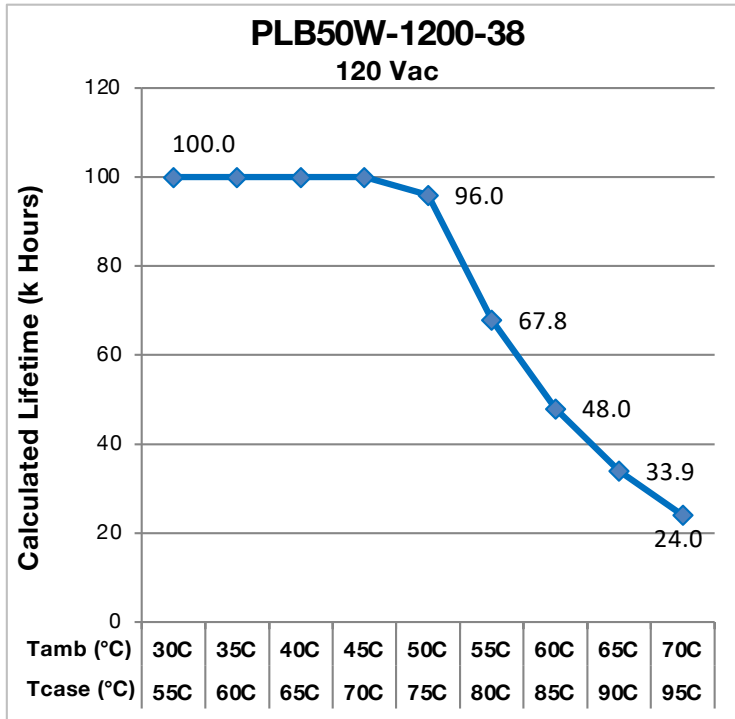

Figure 4

Notes:

- The above lifetime graphs were generated with the driver attached to a baseplate of dimensions 250 x 90 x 2 mm.
- The ambient temperature  $T_{ambient}$  and the differential between  $T_{ambient}$  and  $T_{case}$  mentioned in the above graphs are relevant only as long as both the driver and the light fixture are exposed to the same ambient room temperature. If the LED driver is housed in an enclosure or covered by insulation material, then the ambient room temperature is no longer valid. In this situation, please refer only to the case temperature  $T_{case}$ .
- It should be noted the graph "Lifetime vs. Ambient Temperature" may have an error induced in the final application if the mounting has restricted convection flow around the case. For applications where this is evident, the actual case temperature measured at the  $T_c$  point in the application should be used for reliability calculations.
- Users must utilize proper thermal management techniques to ensure proper thermal conductivity between the driver and heat sink. The use of double-sided tape to mount the driver voids the warranty.



POWER + LIGHT™

# PLB50/30/15 Series

<b>PLB50</b>	<b>50 W</b>
<b>PLB30</b>	<b>30 W</b>
<b>PLB15</b>	<b>15 W</b>

## Low Profile (0.72" H x 0.72" W), Programmable, Constant Current Class 2 LED Driver with 0-10 V Dimming

### 11 – EFFICIENCY VERSUS LOAD

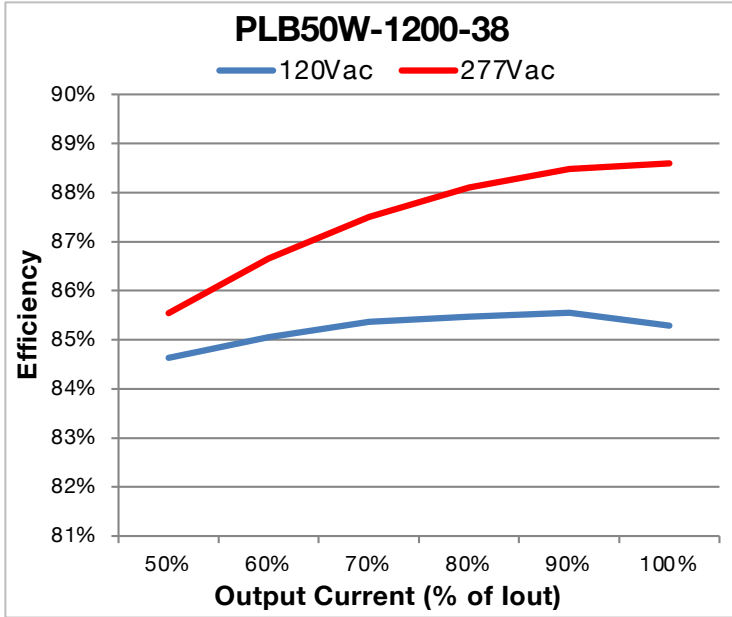

Figure 5

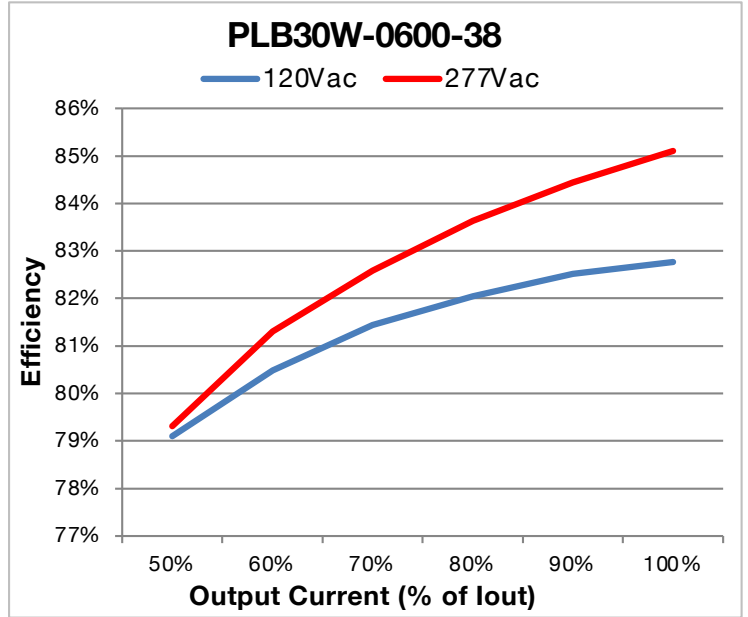

Figure 6

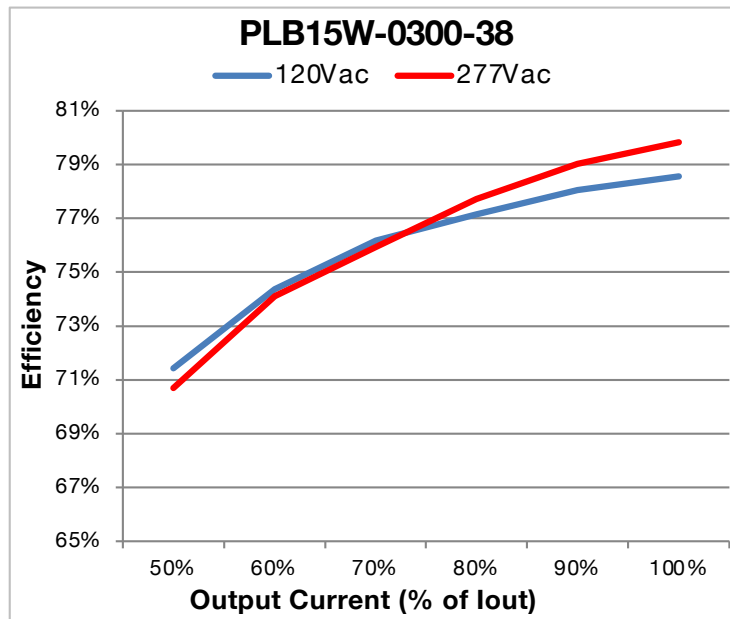

Figure 7

## Low Profile (0.72" H x 0.72" W), Programmable, Constant Current Class 2 LED Driver with 0-10 V Dimming

### 12 – POWER FACTOR VERSUS LOAD

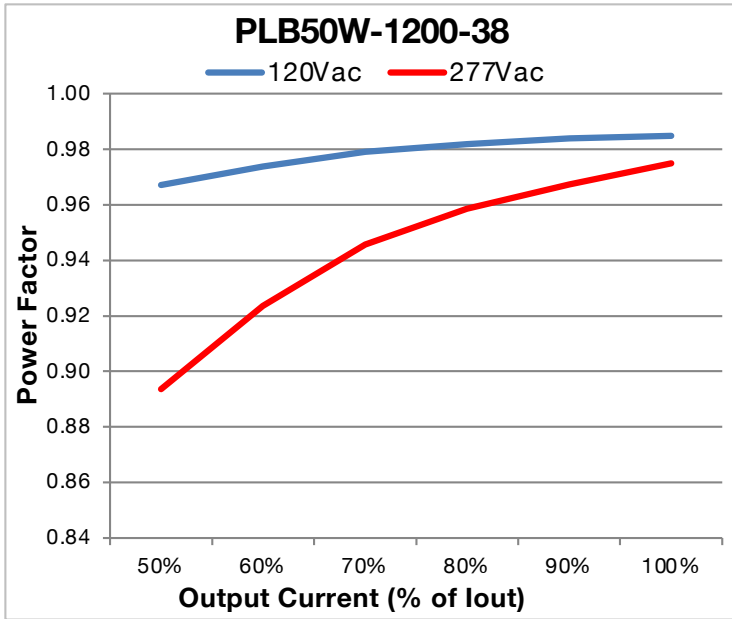

Figure 8

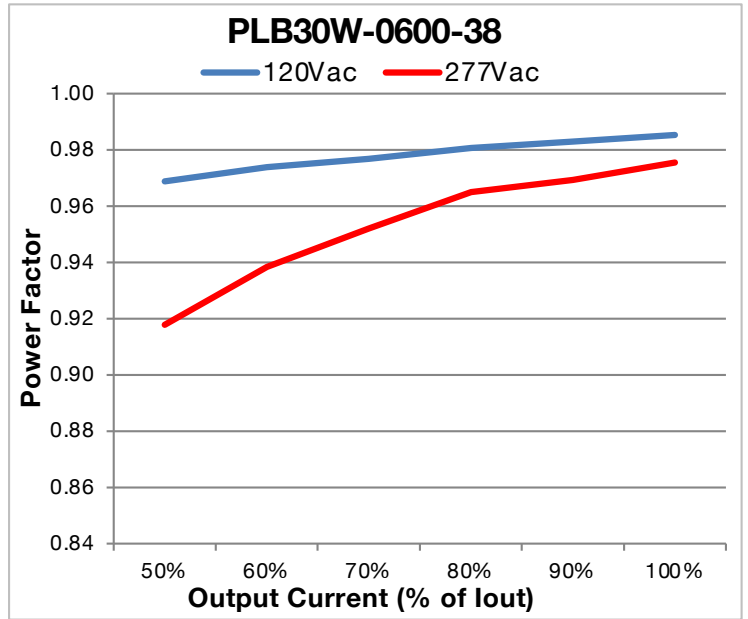

Figure 9

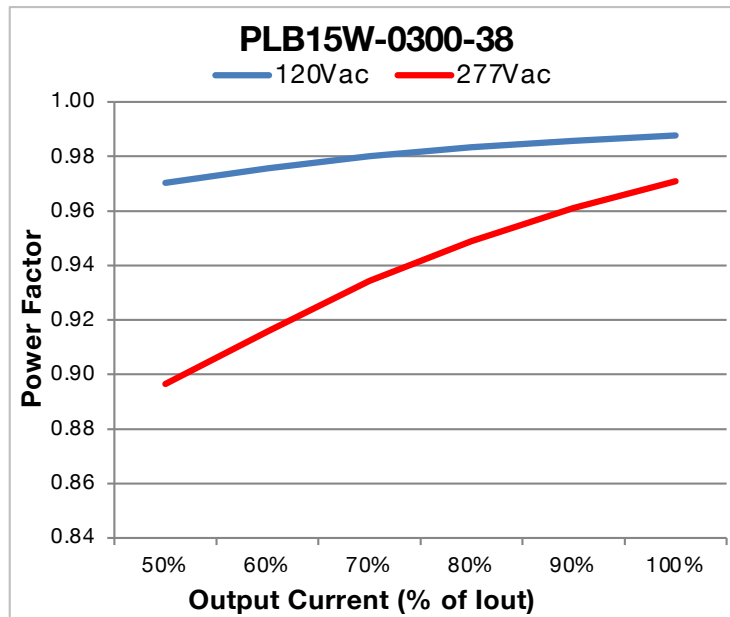

Figure 10



POWER + LIGHT™

# PLB50/30/15 Series

<b>PLB50</b>	<b>50 W</b>
<b>PLB30</b>	<b>30 W</b>
<b>PLB15</b>	<b>15 W</b>

## Low Profile (0.72" H x 0.72" W), Programmable, Constant Current Class 2 LED Driver with 0-10 V Dimming

### 13 - THD VERSUS LOAD

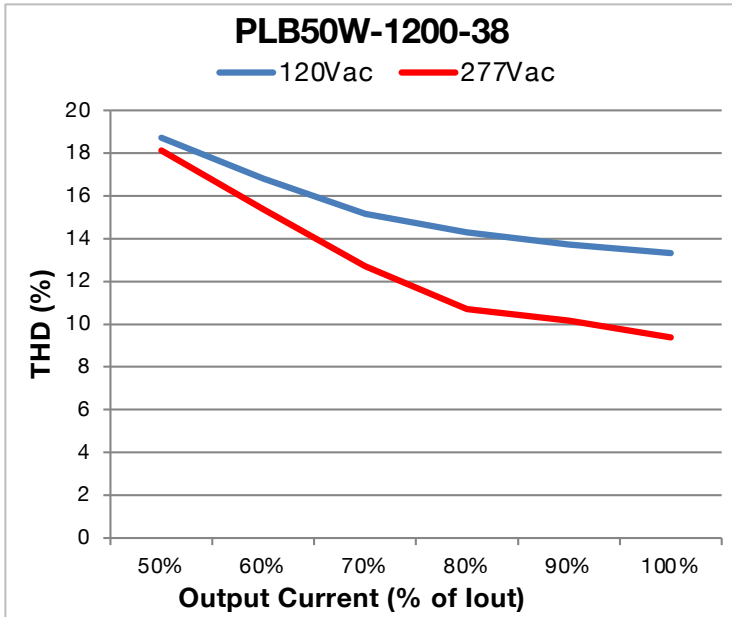

Figure 11

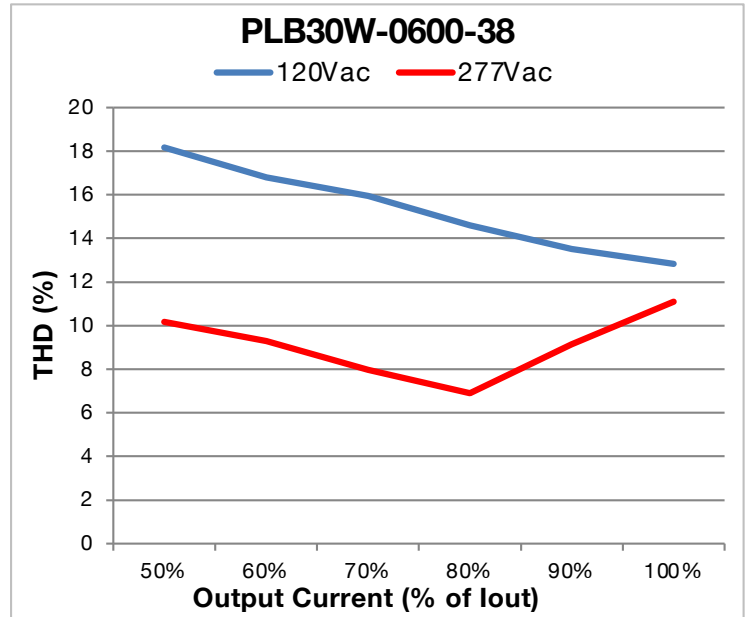

Figure 12

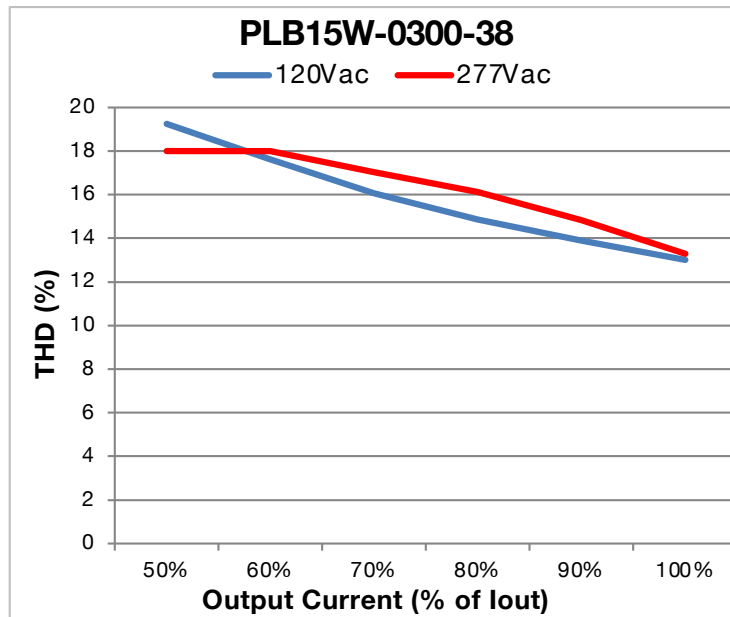

Figure 13

## Low Profile (0.72" H x 0.72" W), Programmable, Constant Current Class 2 LED Driver with 0-10 V Dimming

### 14 - MECHANICAL DETAILS

- **Packaging:** Aluminum case
- **I/O Connections:** 18 AWG on input and output leads, 22 AWG on 0-10V dimming wires, 105°C rated, stranded, stripped by approximately 9.5 mm, and tinned. All the wires, on both input and output, have a 300 V insulation rating.
- **Wire Length:**
  - AC Neutral (White): 152 mm (6 inches)
  - AC Phase (Black): 203 mm (8 inches)
  - LED Output (+ Red): 203 mm (8 inches)
  - LED Output (- Blue): 152 mm (6 inches)
  - + Dim (Purple): 457 mm (18 inches)
  - - Dim (pink): 508 mm (20 inches)
- **Ingress Protection:** IP20 rated
- **Mounting Instructions:** The PLB driver case must be secured on a flat surface through the two mounting tabs, shown here below in the case outline drawings. The use of double-sided tape voids the warranty.

### 15 - OUTLINE DRAWINGS (MODELS WITH FLYING LEADS)

**Dimensions:** L 198.7 \* W 18.25 \* H 18.25 mm (L 7.82 \* W 0.72 \* H 0.72 in.)

**Volume:**

**Weight:**

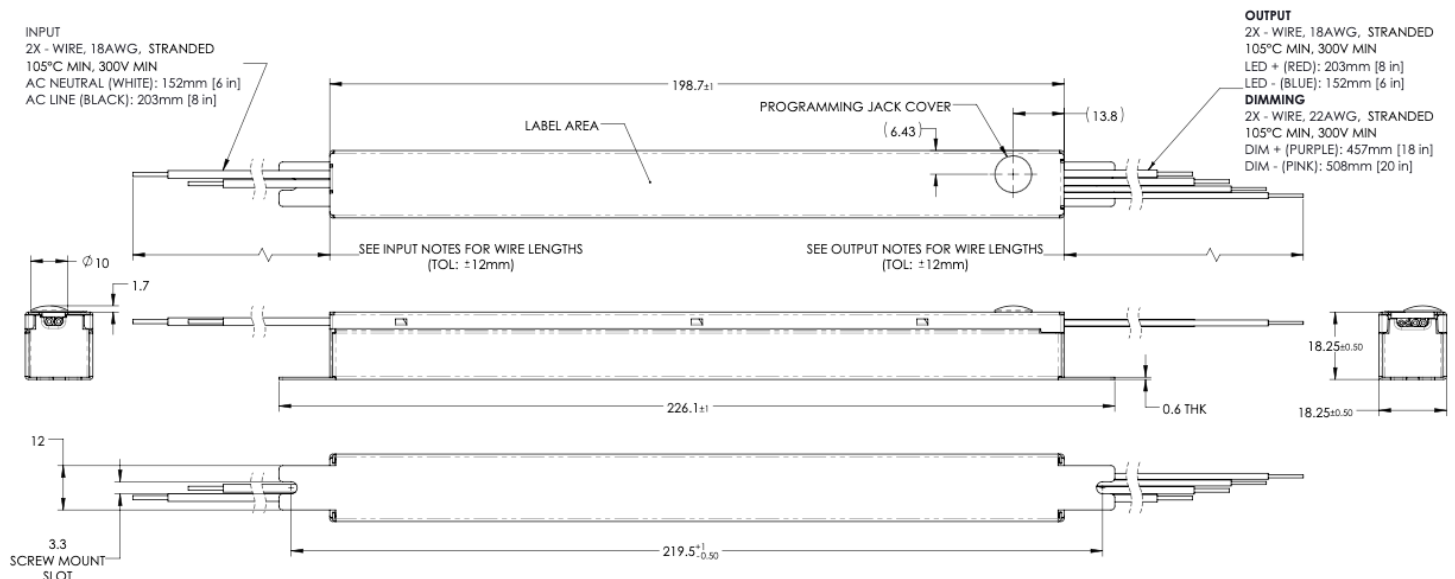

**Figure 14**



POWER + LIGHT™

# PLB50/30/15 Series

<b>PLB50</b>	<b>50 W</b>
<b>PLB30</b>	<b>30 W</b>
<b>PLB15</b>	<b>15 W</b>

## Low Profile (0.72" H x 0.72" W), Programmable, Constant Current Class 2 LED Driver with 0-10 V Dimming

### 16 - LABELING

The PLB50W-1200-38 is used in figure 15 as an example to illustrate a typical label.



 <b>PLB50W-1200-38</b> Dimmable Constant Current LED Driver Max Case Temperature Tc = 90°C Suitable for Operation with 0-10V Dimmer Suitable for Dry or Damp Locations	<b>AC INPUT:</b> 120/277 V ~ 0.50A 50/60 Hz PF ≥ 0.9, THD ≤ 20% L: BLACK N: WHITE	<div style="border: 1px solid black; width: 100%; height: 100%; display: flex; align-items: center; justify-content: center;"> <span>(serial label)</span> </div>	Designed in the USA Manufactured in China  <div style="border: 1px solid black; width: 100%; padding: 2px;"> <b>CONFIGURATION AFTER PROGRAMMING</b>          (Default Current Setting: 0.6 A)       </div>	  Class 2  <small>Use ERP Supplied Cables Only for Programming</small>	<b>DC OUTPUT:</b> Programmable Current 0.60-1.20 A --- Maximum Power 45.6 W Voltage Range 26-38 Vdc No Load Voltage 50 Vdc LED +: RED LED -: BLUE DIM +: PURPLE DIM -: PINK (or GREY) <small>Class 1 wiring or Class 2 - For 0-10V Dimming</small>
---	--	---	---	--	---

Figure 15

**USA Headquarters**  
 Tel: +1-805-517-1300  
 Fax: +1-805-517-1411  
 2625 Townsgate Road, Suite 106  
 Westlake Village, CA 91361, USA

**CHINA Operations**  
 Tel: +86-756-6266298  
 Fax: +86-756-6266299  
 No. 8 Pingdong Road 2  
 Zhuhai, Guangdong, China 519060

ERP Power, LLC (ERP) reserves the right to make changes without further notice to any products herein. ERP makes no warranty, representation or guarantee regarding the suitability of its products for any particular purpose, nor does ERP assume any liability arising out of the application or use of any product or circuit, and specifically disclaims any and all liability, including without limitation special, consequential or incidental damages. "Typical" parameters which may be provided in ERP data sheets and/or specifications can and do vary in different applications and actual performance may vary over time. All operating parameters, including "Typicals" must be validated for each customer application by customer's technical experts. ERP does not convey any license under its patent rights nor the rights of others. ERP products are not designed, intended, or authorized for use as components in systems intended for surgical implant into the body, or other applications intended to support or sustain life, or for any other application in which the failure of the ERP product could create a situation where personal injury or death may occur. Should Buyer purchase or use ERP products for any such unintended or unauthorized application, Buyer shall indemnify and hold ERP and its officers, employees, subsidiaries, affiliates, and distributors harmless against all claims, costs, damages, and expenses, and reasonable attorney fees arising out of, directly or indirectly, any claim of personal injury or death associated with such unintended or unauthorized use, even if such claim alleges that ERP was negligent regarding the design or manufacture of the part. ERP is an Equal Opportunity/Affirmative Action Employer. This literature is subject to all applicable copyright laws and is not for resale in any manner.



# PLB50/30/15 Series

<b>PLB50</b>	<b>50 W</b>
<b>PLB30</b>	<b>30 W</b>
<b>PLB15</b>	<b>15 W</b>

Low Profile (0.72" H x 0.72" W), Programmable,  
Constant Current Class 2 LED Driver with 0-10 V Dimming

## Revision History

Date	Comments
30APR2020	<ul style="list-style-type: none"><li>Initial release</li></ul>
09JUN2020	<ul style="list-style-type: none"><li>Pg13: corrected wire length in section 14</li></ul>
23JUL2020	<ul style="list-style-type: none"><li>Pg14: updated label image</li></ul>
21SEP2020	<ul style="list-style-type: none"><li>Various grammar changes</li></ul>
27APR2021	<ul style="list-style-type: none"><li>Pg2: added Vout max statement</li></ul>
16JUL2021	<ul style="list-style-type: none"><li>Pg1,13-14: Updated images</li></ul>
11JAN2022	<ul style="list-style-type: none"><li>Pg2: added "-FN" part numbers</li></ul>
28MAR2023	<ul style="list-style-type: none"><li>Pg1: added RoHS logo</li><li>Pg2: removed "-FN" part numbers</li></ul>